

PROMOȚIE

MAȘINI ȘI ACCESORII
PRELUCRARE
METALE ȘI LEMN

WWW.PROMA.RO

2024



SHOWROOM PROMA PENTRU VIZUALIZARE ȘI TESTARE MAȘINI-UNELTE ȘI UTILAJE



PACHETE ECONOMICE PENTRU SERVICII POST-GARANȚIE ȘI REVIZII PERIODICE



SOLUȚII OPTIMIZATE PENTRU INSTALARE ȘI PUNERÉ ÎN FUNCȚIUNE



INSTRUIRE ȘI EVALUARE COMPETENȚE UTILIZARE



EXPERIENȚĂ CONSOLIDATĂ - 18 ANI ÎN INDUSTRIE



GARANȚIE PRODUSE DE PÂNĂ LA 10 ANI



CONSULTANȚĂ TEHNICĂ AVANSATĂ

sahtinler
METAL MAKINA ENDÜSTRİ A.Ş.

PILOUS

DENER
MACHINERY

biegemaster

BEKAMAK

FERVI

MARD

GEKA
The steel working company

HIDROLIKSAN
HALIM USTA

NARGESA

NEBES

elsa

İleri Teknik
Innovative Sawing Technologies

ZMM
BULGARIA

CANSA MAKINA
SANAYİ VE TIC. LTD. ŞTİ.

PROMA

NIKMANN
MASCHINEN

Promoție valabilă în
limita stocului disponibil
în perioada 10.05-31.12.2024

PROMA MACHINERY S.R.L.
Show-Room si Birouri: Sos. Centura , nr. 45, com. Chiajna, jud. Ilfov
Telefon: 021 448 04 66, 021 448 04 50 e-mail: vanzari@proma.ro site: www.proma.ro

DETALII BENEFICII

GARANTIE 12 Luni	Produsele marcate cu acest simbol beneficiaza de o garantie de 12 luni	GARANTIE 24 Luni	Produsele marcate cu acest simbol beneficiaza de o garantie de 24 luni	GARANTIE 36 Luni	Produsele marcate cu acest simbol beneficiaza de o garantie de 36 luni	GARANTIE 60 Luni	Produsele marcate cu acest simbol beneficiaza de o garantie de 60 luni
GARANTIE 120 Luni	Produsele marcate cu acest simbol beneficiaza de o garantie de 120 luni	TRANSPORT GRATUIT	Produsele marcate cu acest simbol beneficiaza de transport gratuit.	PIF GRATUIT	Produsele marcate cu acest simbol beneficiaza de punere in functiune gratuita cu deplasare.	ASISTENTA DE LA DISTANTA	Produsele marcate cu acest simbol beneficiaza gratuit de punere in functiune asistata la distanta.
		3-6 RATE	Produsele marcate cu acest simbol beneficiaza de posibilitatea de plata in rate.	ACHIZITIE INTRACOMUNITARA	Produsele marcate cu acest simbol beneficiaza de posibilitate achizitie intracomunitara		

Vezi detalii si conditii de garantie pe: www.proma.ro/garantia-produselor

CUPRINS

• Fierastraiie debitat metale	pag. 1 – 8	• Prese manuale	pag. 65
• Strunguri pentru metale	pag. 9 – 16	• Masini de roluit tabla	pag. 66 – 68
• Masini de rectificat metale	pag. 16	• Utilaje tinichigerie	pag. 69
• Masini de frezat metale	pag. 16 – 18	• Masini de bordurat tabla	pag. 70
• Masini de gaurit metale	pag. 18 – 22	• Masini debitat tabla circular	pag. 71
• Masini de mortezat metale	pag. 22 – 23	• Foarfeci ghilotina tabla	pag. 71 – 73
• Polizoare de banc	pag. 23 – 26	• Utilaje si linii productie tubulatura industriala	pag. 74 – 75
• Masini de ascutit scule	pag. 26 – 27	• Masini de taiat cu plasma	pag. 75
• Masini de debavurat si slefuit metale	pag. 28	• Masini de sanfrenat tabla	pag. 76
• Masina de electroeroziune	pag. 28	• Masini de fasonat si debitat otel-beton	pag. 77 – 78
• Masini de filetat si gaurit metale	pag. 29 – 30	• Chei fasonat otel beton	pag. 79
• Masini de roluit profile	pag. 32 – 34	• Foarfece debitat otel beton	pag. 79
• Masini de indoit tevi cu si fara dorn	pag. 35 - 36	• Masini de confectionat etrieri	pag. 79 – 81
• Dispozitive de indoit profile	pag. 37	• Fierastraiie debitat circular pentru lemn	pag. 83 – 84
• Masini de sanfrenat si debitat tevi	pag. 38	• Fierastraiie verticale cu banda pentru lemn	pag. 84
• Dispozitive pozitionare tevi	pag. 38	• Gatere	pag. 84
• Masini de slefuit metale	pag. 38 – 39	• Masini de frezat lemn	pag. 85
• Masini de alezat si sudat	pag. 40	• Masini pentru grosime	pag. 85
• Utilaje pentru fier forjat	pag. 41 – 43	• Masini de rindeluit lemn	pag. 85 – 86
• Masini pentru sablat	pag. 44 – 45	• Masini de mortezat	pag. 86 – 87
• Linii automate pentru gaurit profile	pag. 46 – 48	• Masini de slefuit lemn	pag. 87
• Foarfeci combinate hidraulice	pag. 48 – 51	• Masini de aplicat cant	pag. 87
• Foarfeci manuale	pag. 51	• Strunguri pentru lemn	pag. 88
• Prese servo electrice tip abkant cu CNC	pag. 53	• Masini combinate prelucrare lemn	pag. 89
• Prese hidraulice tip abkant cu CNC	pag. 54 – 57	• Aspiratoare pentru rumegus	pag. 90
• Prese tip abkant electrice	pag. 58 – 60	• Accesorii masini unlete	pag. 92 - 97
• Prese tip abkant manuale	pag. 60	• Aparate de masura si control	pag. 97 – 99
• Prese hidraulice de atelier	pag. 62 – 63	• Echipamente de manipulat	pag. 99 – 100
• Prese hidraulice universale	pag. 62 – 63	• Truse scule, diverse scule	pag. 100 – 101
• Prese cu excentric	pag. 64		
• Prese orizontale	pag. 65		

Preturile sunt exprimate in euro si nu contin TVA, facturarea se face la cursul BNR

Oferta este supusa unor termene si conditii si este valabila pana la 31/12/2024

Fotografiile au caracter informativ si pot contine anumite accesorii care nu sunt incluse in pachetul standard de livrare sau se pot modifica fara notificare prealabila

Livrarea si plata produselor se face conform cu conditiile comerciale ale societatii noastre.

S.C PROMA MACHINERY SRL isi rezerva dreptul de a modifica conditiile de livrare si preturile din catalog fara notificare in prealabil.

Nu ne asumam raspunderea pentru eventualele greseli de tipar sau erori.



Czech Republic



Made in EU

PILOUS

PROFESSIONAL BANDSAWS

PROFESSIONAL BAND SAWS FOR METAL AND WOOD

PILOUS s-a infiintat in **1994**. Inca de la inceput, succesul si dezvoltarea continua rapida a **PILOUS** a fost posibila prin **punerea accentului pe constructia de ultima generatie si calitatea masinilor**.

Utilizarea de noi tehnologii si metode, constructia robusta a masinilor si designul asigura o durata de viata lunga si precizie de taiere.

Constructia actuala de fierastrai pentru metal si fierastrai pentru lemn prezinta cel mai inalt standard din lume si defineste, in multe moduri, tendintele dezvoltarii ulterioare in domeniu.

Numarul de masini fabricate a crescut de la an la an si noi tipuri au fost dezvoltate rapid. In prezent, compania ofera aproximativ **40 de tipuri de fierastrai** cu banda de taiere a metalelor, de la fierastrau **manual** mic pana la **masini CNC industriale**.



100%
FABRICAT IN CEHIA



GRAVITATIONALE



HIDRAULICE GRAVITATIONALE



HIDRAULICE SEMI-AUTOMATE



CNC AUTOMATE



SEMI-AUTOMATE CU DOUA COLOANE



CNC AUTOMATE CU DOUA COLOANE



CNC - AVANS HIDRAULIC MATERIAL



FIERASTRAIE PENTRU LEMN

FIERASTRAU AUTOMAT CU BANDA PENTRU METALE ARG 520 DC CF-NC

COD: ARG520DCCFNC

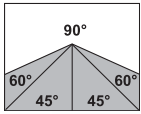

€59,892
€66,984



DOTARE STANDARD

Convertizor de frecventa

Perie curatare panza cu actionare electrica

Regulator presiune

Pistol pulverizator

Iluminare locala cu LED

Conveior eliminat span



5770x41x1,3

Capacitate de taiere	90°
	520 mm
	500 mm
	700 x 480 mm
Inaltimea de lucru	920 mm
Putere motor electric	400 V, 50 Hz, 4 kW
Putere sistem de racire	400 V, 50 Hz, 0,12 kW
Servomotor avans	400 V, 50 Hz, 4,5 kW
Putere motor hidraulic	400 V, 50 Hz, 1 kW
Greutate utilaj	3100 kg

Masina automata masiva cu doua coloane conceputa pentru a fi utilizata pentru **debitarea industriala** a materialelor pline si a profilelor cu sectiuni mari chiar si in cadrul aplicatiilor dificile de **debitare non-stop**.



- Panoul de control central cu un **ecran tactil color (7.5")** asigura un **control simplu si intuitiv** al tuturor functiilor masinii.
- Unitatea de comanda permite programarea de pana la **60 de programe** pentru stabilirea rapida a lungimii de alimentare in **productii repetitive**.



- Masina este echipata cu un **sistem de alimentare automata cu servomotor** cu angrenaj planetar a piesei.
- Servomotorul si surubul cu bile asigura **viteza mare si precizie maxima** chiar si in cazul alimentarii multiple necesare in cazul in care se debiteaza piese lungi.



- **Prinderea optima a piesei** in timpul taierii este facilitata de o **menghina hidraulica** cu doua falci care prinde materialul atat inainte cat si dupa linia de debitare. Menghina se misca de-a lungul ghidajelor liniare.



- **Menghina de avans extrem de robusta** se deplaseaza de-a lungul ghidajelor liniare.



- Pentru asigurarea posibilitatii debitarii pieselor foarte grele, suprafata de incarcare este echipata cu role robuste pe intreaga lungime, permitand miscare usoara a materialului.

FIERASTRAU AUTOMAT CU BANDA PENTRU METALE ARG 300 CF-NC

COD: ARG300CFNC



€17,854
€19,519

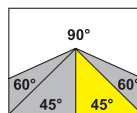

3150x27x1,3

Capacitate de taiere	90°	+45°
	300 mm	240 mm
	285 mm	220 mm
	305 x 290 mm	235 x 130 mm
Inaltimea de lucru	850 mm	
Putere motor electric	400 V, 50 Hz, 2,2 kW	
Putere sistem de racire	400 V, 50 Hz, 0,05 kW	
Putere motor hidraulic	400 V, 50 Hz, 0,35 kW	
Motor avans	1,3 / 2 kW	
Greutate utilaj	1020 kg	



- Panoul de control central cu un **ecran tactil color (7.5")** asigura un **control simplu si intuitiv** al tuturor functiilor masinii.
- Unitatea de comanda permite programarea de pana la **60 de programe** pentru stabilirea rapida a lungimii de alimentare in **productii repetitive**.



- Asa-numitul **design „plutitor”** al **menghinei de alimentare** asigura alimentarea corecta a pieselor inegale si brute.
- Reglarea presiunilor menghinelor de alimentare (mobil) si de prindere (fix) este inclusa in executia de baza a masinii.

Avantaje ale masinii:

- Cadrul foarte robust a masinii se compune din piese turnate din fonta cenusie si asigura absorbtia vibratiilor.
- Conceptul modern al cadrului permite debitarea dreapta si in unghi a unei game largi de materiale.
- Rotile de antrenare si tensionare mari si ghidarea panzei din trei parti cu ajutorul placutelor de ghidare din metal dur asigura masinii inalta precizie de debitare si o durata de viata lunga.
- Supradimensionarea rulmentilor rotii de rulare, sistemul rotii de tensionare si toate partile rotative asigura masinii o durata de viata lunga
- Masina este dotata cu un sistem de racire complet cu o pompa de inalta performanta si posibilitatea de reglare a debitului de pe ambele cuburi de ghidare a panzei.
- Masina verifica tensionarea corecta sau ruperea panzei fierastrau. In cazul in care panza fierastrau se rupe masina se opreste automat.
- Legat de dotare standard aceasta o putem face mai mica / comprimata nu este asa relevanta la acest model

DOTARE STANDARD

Convertizor de frecventa

Pistol pulverizator



FIERASTRAU SEMIAUTOMAT CU BANDA PENTRU METALE ARG 300 Plus E H F

COD: ARG300plusEHF



3150×27×0,9



Capacitate de taiere	90°
	300 mm
	290 mm
	360 x 190 mm
Unghi taiere	90°, -45°, +45°, +60°
Putere motor	1,2/1,55 kW / 400V
Putere sistem de racire	400 V, 0,05 kW
Greutate utilaj	478 kg

€6800
€7550



FIERASTRAU CU BANDA PENTRU METALE ARG260 PLUS E

COD: ARG260PLUSE



2880×27×0,9



Capacitate de taiere	90°
	260 mm
	240 mm
	300 x 165 mm
Unghi taiere	90°, +45°, +60°
Putere motor	0,9 kW/1.4 kW /400V
Putere sistem de racire	400 V, 0,05 kW
Greutate utilaj	310 kg

€3990
€4173

Livrare imediata din stoc



FIERASTRAU CU BANDA PENTRU METALE ARG 300 F | ARG 300 HF



BEST SELLER

Incepand cu
€5736

MODEL	ARG 300 F	ARG 300 HF
	300 mm	300 mm
	290 mm	290 mm
	375 x 190mm	375 x 190mm
Unghi taiere	90°, 60°, +45°	
Putere Motor	2,2 kW/400V	
Greutate	455 kg	470 kg
Ridicare hidraulica brat	-	✓
COD	ARG300F	ARG300HF
Pret lista	€ 6,092	€ 7,105
Pret promotie	€ 5,736	€ 6,690



- Menghina masiva cu strangere rapida care asigura prinderea materialului usoara si fiabila
- Ajustarea continua a unghiului de debitare 90° - 45° - 60°



- Sistem de racire complet cu o pompa de performanta si posibilitatea reglare a debit.
- Rezervorul pentru lichidul de racire este amplasat In suportul masinii.

Masina este echipata cu un limitator reglabil cu lungimea de 500 mm.



DOTARE STANDARD

Convertizor de frecventa

Perie curatare panza cu actionare electrica

FIERASTRAU CU BANDA PENTRU METALE ARG 235

COD: ARG235

2710×27×0,9



BEST SELLER

€3280
€3500

Capacitate de taiere	90°
	235 mm
	230 mm
	280 x 180 mm
Unghi taiere	90°, 60°, +45°
Motor principal	400 V, 50 Hz, 0,9/1,4 kW
Pompa sistem racire	400 V, 50 Hz, 0,05 kW
Inaltimea de lucru	900 mm
Dimensiunile masinii	1870 x 1300 x 2000 mm
Greutatea	285 kg

- Cadrul robust compus din piese turnate fonta cenusie care asigura absorbtia vibratiilor.

- Supradimensionarea rulmentilor, al sistemului de tensionare si toate partile rotative asigura masinii o durata de viata lunga



- Menghina masiva cu strangere rapida care asigura prinderea materialului usoara si fiabila
- Ajustarea continua a unghiului de debitare 90° - 45° - 60°



- Sistem de racire complet cu o pompa de performanta si posibilitatea reglare a debit.
- Rezervorul pentru lichidul de racire este amplasat In suportul masinii.

Masina este echipata cu un limitator reglabil cu lungimea de 500 mm.

Livrare imediata din stoc



FIERASTRAU CU BANDA PENTRU METALE ARG130 TK 230V

COD: ARG130TK230V



1730×13×0,65



Capacitate de taiere	90°
	130 mm
	130 mm
	180 x 100 mm
Unghi taiere	90°, 60°, +45°
Putere motor	0,37/0,55 kW/230V
Greutate	77 kg

- Sistem de racire incluz



€1850
€1888

FIERASTRAU CU BANDA PENTRU METALE ARG 105 MOBIL

COD: ARG105MOBIL



1385×13×0,65



Capacitate de taiere	90°
	105 mm
	105 mm
	105 x 100 mm
Unghi taiere	90°, 60°, +45°
Putere motor	0,55 kW/230V
Greutate	29 kg

- Usor de transportat pe santier



€1195
€1225

Infiintata ca o companie de familie in 1984, BEKAMAK este considerata a fi companie pionier, deschizand sectorul fierastrailor de debitat metal din Turcia catre exportul in intreaga lume. Incepend cu prima sa livrare din anul 1990, in Germania, BEKAMAK este acum reprezentata in aproape 90 de tari de catre 60 de distribuitori din intreaga lume, in principal in Europa, Rusia si Statele Unite. Masinile de taiat metale cu banda dar si cu disc marca BEKAMAK functioneaza cu o eficienta ridicata fiind prima alegere intre producatorii de otel din Turcia.

DE CE BEKAMAK

- 40 de ani de experiență
- Fierăstraiele BEKAMAK debitează metalul in peste 90 de țări
- Departament propriu de cercetare și dezvoltare
- Departament asigurare servicii post-vânzare
- Fabricate cu componente de la branduri de renume
- Orientat către nevoile clienților in procesele de productie
- Raport calitate-preț performant
- Peste 120 de modele diferite de fierăstraie

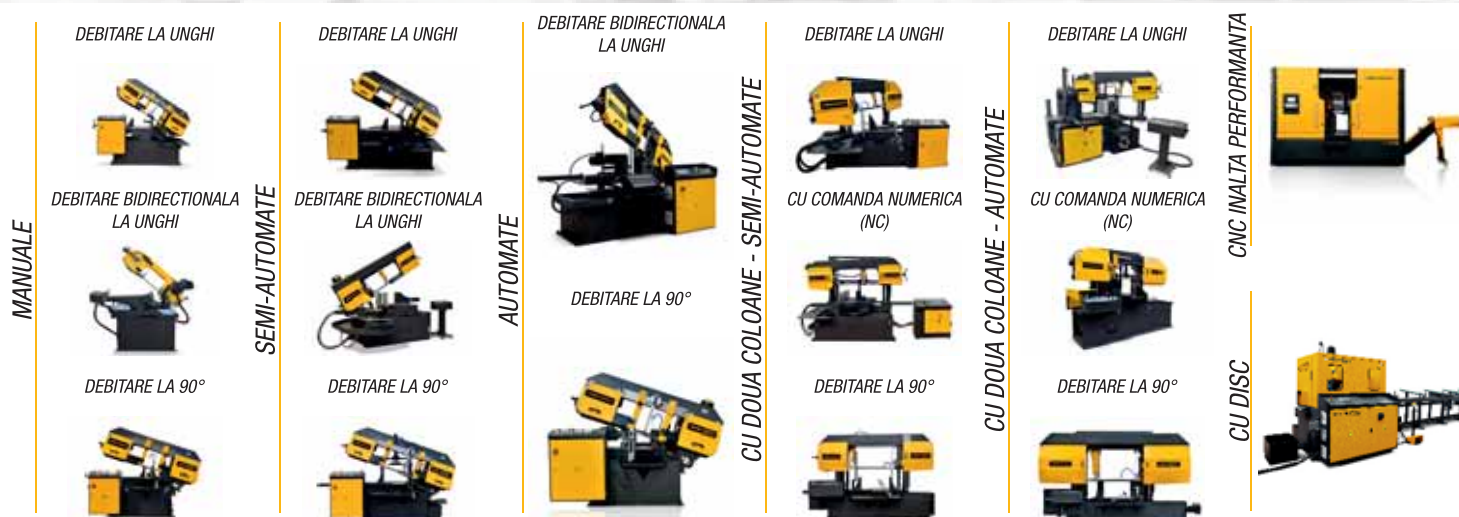

Compania **BEKAMAK**, care isi desfasoara activitatea intr-o unitate de 10.500 m², cu cei 230 angajati calificati, continua sa contribuie la industria siderurgica prin filozofia sa de permanenta dezvoltare si inovare. Incepend cu anul 2018 firma a infiintat oficial departamentul de cercetare si dezvoltare. In prezent 35 de ingineri si tehnicieni sunt implicati in acest departament.



FIERASTRAU CU DISC PENTRU DEBITAT OTEL BMD0 100 CS

COD: BMD0100CS



Capacitate taiere la +90°	20-100 mm
Deschidere menghina (max)	110 mm
Lungime avans	1000 mm
Dimensiuni disc	260 – 350 2.0t – 3.0t (max) mm
Viteza lucru	22 - 130 m/min.
Inaltime de lucru	900 mm
Putere motor principal	5,5 kW
Putere motor pompa de racire / conveier	0,2 kW / 0,25 kW
Putere motor hidraulic	1,5 kW
Putere motor avans	1 kW
Greutate	1900 kg

€54446
€56571

DOTARE STANDARD



Perie rotativa pentru curatare span



Prevazut cu sigurante de protectie la deschiderea neautorizata



Modul de comanda si automatizare



Menghina hidraulica



Motoreductor de antrenare a benzii de debitare



Disc circular tip HSS

Avan taje ale masinii:

- Posibilitatea de a programa mai multe lungimi de taiere pentru fiecare bara.
- Interfața intuitiva și ușor de utilizat, cu ecran tactil.
- Sistem servo avans pentru o precizie a lungimii de taiere de +/- 0,05 ~ 0,1 mm (pe cursa).

FIERASTRAU SEMIAUTOMAT CU BANDA PENTRU METALE BMSY 810 C

COD: BMSY810C

8200×41×1,3



€32056
€33307

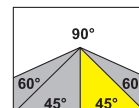

Avantaje sistem debitare cu 2 coloane

- Precizie de debitare ridicata
- Viteza de taiere mai mare
- Nu apar vibratii la taiere
- Durata de viata a panzei mai mare
- Rigiditate si fiabilitate mai mare in timp

Capacitate taiere	+90°	+45°
●	810 mm	480 mm
■	850 x 810 mm	480 x 810 mm
■	810 mm	480 mm
Inaltime de lucru	585	
Putere motor principal	4 kW	
Putere motor pompa de racire	0,12 kW	
Putere motor hidraulic	1,5 kW	
Greutate	3080 kg	

DOTARE STANDARD



Masa suport material 1,2 m	Protectie la deschiderea neautorizata	Modul de comanda si automatizari	Perie rotativa pentru curatare span	
Menghina hidraulica	Limitator material	Sistem tensionare panza hidro-mecanic	Motorizare marca Siti	Sistem de racire si lubrifiere panza
Senzor optic limitator cursa	Motoreductor de antrenare a benzii de debitare	Ghidaje unitate taiere liniare	Potentiometru pentru relgarea presiunii de lucru	Inclinare 2° banda fierastrau

*Preturile sunt exprimate in EURO si nu contin T.V.A

FIERASTRAU AUTOMAT CU BANDA PENTRU METALE BMS0 350 GA

COD: BMS0-350GA

4160×34×1,1

BEKAMAK

DOTARE STANDARD

Microintrerupator pentru ajustarea pe inaltime	Menghina hidraulica
Modul de comanda si automatizare	Menghina (verticala) pentru taiere la pachet
Sistem tensionare panza hidro-mecanic	Sistem de racire si lubrifiere panza

Capacitatea de taiere	●	■	■
90°	350 mm	350 mm	400 x 350 mm
+30°	320 mm	350 mm	400 x 350 mm
+45°	320 mm	270 mm	290 x 300 mm
Viteza benzii	20-100 m/min.		
Inaltime de lucru	760 mm		
Putere motor principal	2,2 kW		
Greutate	1050 kg		



€12900
€13933



Masa suport material 1,2 m in dotarea standard



FIERASTRAU SEMIAUTOMAT CU BANDA PENTRU METALE BMSY 360 DGH ECO

COD: BMSY360DGHECO

BEKAMAK

4800×34×1,1

BEST SELLER

€12950
€14615

DOTARE STANDARD

Brat/menghina rotativa	Menghina hidraulica
Sistem de racire si lubrifiere panza	Sistem tensionare panza hidro-mecanic
Convertizor de frecventa	Protectie la deschiderea neautorizata

Capacitatea de taiere	90°
●	360 mm
■	360 mm
■	510 x 360 mm
Unghi taiere	90°, +30°, +45°, +60°, -30°, -45°, -60°
Inaltime de lucru	860 mm
Putere motor principal	3 kW
Putere motor hidraulic	0,37 kW
Putere motor conveyor	0,12 kW
Greutate fierastrau	1450 kg



FIERASTRAU SEMIAUTOMAT CU BANDA PENTRU METALE BMSY-330C

COD: BMSY-330C

BEKAMAK

Avantaje sistem debitare cu 2 coloane

- Precizie de debitare ridicata
- Viteza de taiere mai mare
- Nu apar vibratii la taiere
- Durata de viata a panzei mai mare
- Rigiditate si fiabilitate mai mare in timp

5000×34×1,1



Masa suport material 1,2 m in dotarea standard

DOTARE STANDARD

Menghina hidraulica	Microintrerupator pentru ajustarea pe inaltime
Modul de comanda si automatizare	Sistem sincronizare brat taiere ÷ menghina
Inclinare panza 2°	Ghidaje unitate taiere liniare

Capacitatea de taiere	+90°
●	330 mm
■	360 x 330 mm
■	330 mm
Inaltime de lucru	635
Putere motor principal	3 kW / 400 V
Greutate	1030 kg



€14458
€15315



FIERASTRAU SEMIAUTOMAT CU BANDA PENTRU METALE BMSY 320 GL

COD: BMSY320GL

BEKAMAK

DOTARE STANDARD

Sistem de racire si lubrifiere panza	Menghina hidraulica
Reglare unghi brat debitare	Sistem tensionare panza hidro-mecanic
Microintrerupator pentru ajustarea pe inaltime	Modul de comanda si automatizare

4160×34×1,1

€10480
€13120



Livrare imediata din stoc



Masa suport material 1,2 m in dotarea standard

Capacitatea de taiere	+90°
●	320 mm
■	610 x 320 mm
■	320 mm
Unghi taiere	90°, +30°, +45°, +60°, +75°
Inaltime de lucru	740 mm
Putere motor principal	2,2 kW/400V
Greutate	1200 kg



FIERASTRAU SEMIAUTOMAT CU BANDA PENTRU METALE MPDS-450

COD: 130140-1



Masa suport material 1,2 m in dotarea standard

Avantaje sistem debitare cu 2 coloane

- Precizie de debitare ridicata
- Viteza de taiere mai mare
- Nu apar vibratii la taiere
- Durata de viata a panzei mai mare
- Rigiditate si fiabilitate mai mare in timp



5000×34×1,1

Capacitatea de taiere	+90°
●	330 mm
■	360 x 330 mm
■	330 mm
Inaltime de lucru	635
Putere motor principal	3 kW / 400 V
Greutate	1030 kg

€14458
€15315

Stoc limitat!

DOTARE STANDARD

Microintrerupator pentru ajustarea pe inaltime	Menghina hidraulica
Sistem sincronizare brat taiere ± menghina	Modul de comanda si automatizare
Ghidaje unitate taiere liniare	Inclinare panza 2°



FIERASTRAU CU BANDA PENTRU METALE PPK-200U

COD: 25002000



Avantaje ale masinii:

- Debiteaza otel, aluminiu si alte aliaje
- Se remarca prin constructie solida
- Oferă mobilitate fiind dotat cu roti pentru transport
- Este dotat cu sistem de racire

2360×20×0,9



Capacitatea de taiere	+90°	45°-45°
●	205 mm	135 mm
■	235 x 205 mm	145 x 125 mm
Unghi taiere	90°, 45°	
Inaltime de lucru	740 mm	
Putere motor principal	1,1 kW / 400V	
Greutate	190 kg	

€1898
€2215

Livrare imediata din stoc



FIERASTRAU CU BANDA PENTRU METALE PPK-115UHC

COD: 25000087



Capacitatea de taiere	+90°	45°	60°
●	125 mm	90 mm	56 mm
■	100 x 150 mm	90 x 75 mm	55 x 40 mm
Unghi taiere	90°, 60°, +/-45°		
Inaltime de lucru	730 mm		
Putere motor principal	0,55 kW/230V		
Greutate	90 kg		



1640×13×0,65

Avantaje ale masinii:

- constructie rigida din fonta
- suport de baza mobil

€880
€955



Limitator material si taiere la unghi



Perie curatare span



FIERASTRAU CU BANDA PENTRU METALE 0273

COD: 0273

2470×27×0,9



Capacitatea de taiere	90°
●	220 mm
■	260 mm
■	150 mm
Unghi taiere	0° ÷ 60°
Putere motor principal	1,1 kW / 400 V
Greutate	220 kg

DOTARE STANDARD

sistem de racire menghina prindere rapida sistem tensi-nare panza

€2927
€3253



FIERASTRAU CU BANDA PENTRU METALE TM-205

COD: TM205

2080×20×0,9



Capacitatea de taiere	90°
●	185 mm
■	200 x 140 mm
■	185 mm
Unghi taiere	90°, +45°, +60°
Putere motor principal	2,5 kW/400V
Greutate	174,5 kg

DOTARE STANDARD

menghina de banc sistem de racire
sistem tensionare panza

€2680
€3089

Livrare imediata din stoc



FIERASTRAU CIRCULAR AUTOMAT DK-370

COD: DK-370



€63000
€79954

DOTARE STANDARD

Complet automata	Avans material cu servomotor	Sistem ungere
Afisaj cu ecran tactil	Sistem racire	200 programe

CAPACITATEA DE TAIERE				
Ø disc debitare	350 mm			
Unghi lucru	90°	+/- 45°	+/- 60°	±45°
Rotund	90 mm	80 mm	50 mm	70 mm
Patrat	90 x 90 mm	80 x 80 mm	50 x 50 mm	60 x 60 mm
Rectangular	100 x 80 mm	100 x 40 mm	50 x 50 mm	70 x 55 mm
Putere instalata	6.75 kW / 400 V			
Greutate	1940 kg			



FIERASTRAU CIRCULAR SEMIAUTOMAT V 315 X

COD: V315X



DOTARE STANDARD

Prindere automata a materialului	Ideal pentru productie de serie in loturi mici
Actionare cap debitare hidro-pneumatic	Sistem de racire
Sistem de ungere	Menghina prindere heavy duty

Disc debitare	Ø 315 mm	
Unghi lucru	90°	+/- 45°
●	105 mm	90 mm
■	85 x 85 mm	80 x 80 mm
■	120 x 60 mm	90 x 60 mm
Putere instalata	4,75 kW / 400 V	
Greutate	240 kg	

€4950
€5754



FIERASTRAU CIRCULAR MANUAL V 350 | V 275



Incepad cu

€2990

Stoc limitat!

Model	V 350		V 275	
Disc debitare	Ø 350 mm		Ø 315 mm	
Unghi lucru	90°	±45°	90°	±45°
●	115 mm	110 mm	85 mm	70 mm
■	100 x 100 mm	90 x 90 mm	70 x 70 mm	60 x 60 mm
■	120 x 80 mm	90 x 90 mm	95 x 60 mm	70 x 55 mm
Putere instalata	4,75 kW / 400 V		4,75 kW / 400 V	
Greutate	210 kg		240 kg	
COD	V350		V275	
Pret lista	€ 4755		€ 3986	
Pret promotie	€ 3986		€ 2990	



DOTARE STANDARD

Sistem start / stop
Menghina split heavy duty

FIERASTRAU CIRCULAR MANUAL DT 315 S

COD: DT315S



€3460
€3688

Disc debitare	Ø 315 mm
Unghi lucru	90°
●	105 mm
■	85 x 85 mm
■	120 x 60 mm
Unghi taiere	90° , +/- 45°
Putere instalata	4,75 kW / 400 V
Greutate	200 kg



FIERASTRAU DEBITAT METAL KKS-315

COD: 235315



€2580
€2601

Taiere la	90°
●	55 mm
■	140 x 70 mm
■	85 x 85 mm
Unghi taiere	90°, +45°, -45°
Disc	max. 315 mm
Putere motor	2,2 kW/400V
Greutate	170 kg





100% FABRICAT IN BULGARIA

Strungurile ZMM Bulgaria - proiectare si executie 100% CE, conform DIN 8607.



ZMM Bulgaria Holding, cu o traditie de peste 50 de ani, are in prezent in proprietate 5 fabrici de masini unelte - strunguri, masini de gaurit, fierastrai si accesorii. Toate utilajele sunt gama industriala, pentru productie mijlocie-mare. Sunt robuste, fiabile si precise.

Strunguri universale, strunguri universale cu variator de frecventa, strunguri petroliere, cu NC sau CNC. Diametrele de prelucrare sunt cuprinse intre 325 si 1600 mm si lungimile de lucru de la 500 la 10000 mm.



STRUNGURI UNIVERSALE

Strungurile universale și strunguri cu control infinit variabil au diverse caracteristici și accesorii pentru a satisface nevoile clienților din diverse industrii.



STRUNGURI PETROLIERE

Strungurile petroliere sunt concepute pentru strunjirea țevilor și a accesorilor de țevi pentru industria petrolului și a gazelor. Aceste mașini pot fi utilizate pentru o varietate de operații de strunjire.



STRUNGURI CNC

Strungurile CNC sunt concepute pentru a efectua o gamă largă de operațiuni de strunjire pe piese medii, mari și supradimensionate în producția de serie mică și medie.



STRUNG UNIVERSAL + DOTARI CU1250 x 3000 | CU1000 x 3000

COD: CU12503000EQ | CU10003000EQ



Excelent in uzinare piese complexe mari pentru industriile: energetica, feroviara, navala, petroliera



Incepad cu
€101771

OPTIUNE AFISAJ DIGITAL DE COTE 2 AXE -
NEWALL - ENGLAND NMS800 2-axe



€5399
~~€6062~~

DOTARE STANDARD

Panou de comanda	Sistem de racire
Lampa de iluminat local	Dispozitiv de avans rapid pe 2 axe
Flansa pentru universal Ø 500 mm	Aparatoare spate
Aparatoare universal	Aparatoare portcutit
Curele V=6(8)buc	Set roti dintate de schimb
suruburi reglare orizontalitate	Varf fix de fixare
Dorn de adaptare	Suport portcutit - 4 pozitii
Limitator cursa longitudinala	Maneta fixare rapida papusa mobila
Set scule Palet si ambalaj - folie	Manual de utilizare

Dotari incluse

Universal autocentrant 3 falci, tip 3204/DIN 6350	Universal 4 bacuri interdependente, Cam-lock
Lineta mobila	Lineta fixa - cu bacuri de alunecare plate
Varf rotativ	Sistem franare cu pedala

Date tehnice	CU12503000	CU10003000
Inaltimea de la ghidaje batiu la varfuri	625 mm	500 mm
Diametrul peste ghidaje batiu	1320 mm	1090 mm
Diametrul peste sania transv, la varf cutit	940 mm	690 mm
Diametrul in locas punte	1500 mm	1250 mm
Latimea peste ghidaje batiu	700 mm	
Distanta intre varfuri	3000 mm	
Capul arborelui principal conf. DIN 55027	15 No	
Alezaj arbore principal	155 mm	
Con alezaj arbore	160 Morse	
Trepte ax principal	24 tr.	
Turatii arbore principal	5 - 1000 rot/min	6,3 - 1250 rot/min
Putere motor principal	22 kw	
Numar de avansuri	160	
Numar de filete	80 din fiecare: metric, inch, Module, DP	
Cursa sanie transversala	525 mm	
Conicitatea pinolei	Morse No.6	
Cursa pinola	260 mm	
Greutate strung	8550 kg	8050 kg
Dimensiuni gabarit strung LxIxH	5200 x 1750 x 1990 mm	5200 x 1750 x 1855 mm
COD	CU12503000EQ	CU10003000EQ
Pret lista	€ 120,585	€ 114,269
Pret promotie	€ 107,396	€ 101,771



STRUNG UNIVERSAL + DOTARI CU630 x 3000

COD: CU6303000EQ



+ Optional DRO **5373 Euro**

€44642
€50125

Sunt recomandate in productia pieselor de serie mijlocie - mare, in ateliere de intretinere si reparatii.

Dotari incluse

Universal autocentrant cu 3 falci

Universal 4 bacuri independente, Cam-lock

Varf rotativ

Lineta mobila

Lineta fixa

Sistem franare cu pedala

- Dotare standard:
- Panou de comandă
 - Sistem de răcire
 - Lampă de iluminat local
 - Dispozitiv de avans rapid pe 2 axe
 - Flanșă pentru universal Ø 315 mm, DIN 6350
 - Aparatoare spate si universal
 - Aparatoare portcutit
 - Varf fix de fixare
 - Dorn de adaptare
 - Suport portcutit – 4 poziții
 - Limitator cursa longitudinală
 - Maneta fixare rapida pupusa mobila

Date tehnice	CU630x3000
Diametrul peste ghidaje batiu	630 mm
Lățimea peste ghidaje batiu	400 mm
Distanța dintre varfuri	3000 mm
Trecere ax	103 mm
Turatii	12,5 - 1250 rot/min
Numar avansuri	120
Numar filete (metric, inch, module, DP)	64 de fiecare
Putere motor	11 kW/400V
Greutate	3590 kg



STRUNG UNIVERSAL + DOTARI CU580MRD 11KW x 2000

COD: CU580MRD11KW2000EQ



+ Optional DRO **4015 Euro**

€41194
€46253

Pentru uzinare piese serie mijlocie-mare, unicate grele-complexe

Dotari incluse

Universal autocentrant cu 3 falci

Universal 4 bacuri independente, Cam-lock

Varf rotativ

Lineta mobila

Lineta fixa

Sistem franare cu pedala

- Dotare standard:
- Panou de comanda
 - Motor cu convertizor de frecventa
 - Capul arborelui principal conf. DIN 55027
 - Sistem de racire
 - Lampa de iluminat local
 - Dispozitiv de avans rapid pe 2 axe
 - Flansa pentru universal DIN 6350
 - Aparatoare spate, universal si portcutit
 - Bolturi pentru fundatie (ancorare)
 - Varf fix de fixare
 - Dorn de adaptare
 - Suport portcutit – 4 pozitii
 - Limitator cursa longitudinala
 - Maneta fixare rapida pupusa mobila

Date tehnice	CU580MRD11KW2000
Diametrul peste ghidaje batiu	580 mm
Lățimea peste ghidaje batiu	400 mm
Distanța dintre varfuri	2000 mm
Trecere ax	72 mm
Turatii	25 - 100; 100 - 400; 500 - 2000 rot/min
Numar avansuri	120
Numar filete (metric, inch, module, DP)	64 de fiecare
Putere motor	11 kW
Greutate	3190 kg



STRUNG UNIVERSAL + DOTARI CU500 x 2000

COD: CU5002000EQ



+ Optional DRO 4002 Euro

Dotari incluse

Universal autocentrant cu 3 falci

Universal cu 4 bacuri independente

Lineta fixa

Varf rotativ

Lineta mobila

Mandrina gaurire

Sistem franare cu pedala

€35081

€39389

Pentru uzinare dimenisuni medii, recomandate atelierelor de scularie, intretinere si productie

Diametru strunjire peste batiu	500 mm
Distanta dintre varfuri	2000 mm
Trecere ax	62 mm
Turatii	20 - 2000 rot/min
Putere motor	7,5 kW/400V
Greutate	2630 kg



STRUNG UNIVERSAL CU400MRD x 1000

COD: CU400MRD1000



+ Optional DRO 3207 Euro

DOTARE STANDARD

Lampa de iluminat local

Dispozitiv de avans rapid pe 2 axe

Dorn de adaptare

Sistem de racire

Flansa pentru universal 250 mm

Varf fix de fixare

Suport portcutit - 4 pozitii

€32073

€36012

Pentru uzinare piese serie mijlocie-mare, unicate grele-complexe

Diametru strunjire peste batiu	440 mm
Distanta dintre varfuri	1000 mm
Trecere ax	72 mm
Turatii	25 - 2000 rot/min
Putere motor	11 kW/400V
Greutate	2670 kg



STRUNG UNIVERSAL + DOTARI CU400 x 1500

COD: CU4001500EQ



+ Optional DRO 3485 Euro

Dotari incluse

Universal autocentrant cu 3 falci

Universal cu 4 bacuri independente

Lineta fixa

Varf rotativ

Lineta mobila

Mandrina gaurire

Sistem franare cu pedala

€31393

€35249

Pentru uzinare dimenisuni medii, recomandate atelierelor de scularie, intretinere si productie

Diametru strunjire peste batiu	440 mm
Distanta dintre varfuri	1500 mm
Trecere ax	62 mm
Turatii	20 - 2000 rot/min
Putere motor	7,5 kW/400V
Greutate	2360 kg



STRUNG UNIVERSAL + DOTARI CU325 x 1000

COD: CU3251000EQ



+ Optional DRO 3087 Euro

Dotari incluse

Universal autocentrant cu 3 falci

Universal cu 4 bacuri independente

Lineta fixa

Varf rotativ

Lineta mobila

Mandrina gaurire

Sistem franare cu pedala

€15848

€17794

Recomandate in prelucrari prin aschiere din mecanica fina, sdv-istica, matriterie, ateliere de intretinere si reparatii

Diametru strunjire peste batiu	325 mm
Distanta dintre varfuri	1000 mm
Trecere ax	32 mm
Turatii	85 - 2000 rot/min
Putere motor	2,2 kW/400V
Greutate	770 kg





Din 1996 PROMA produce si comercializeaza masini-unelte pentru prelucrare metal, tabla, profile si lemn, adaptate perfect necesitatilor actuale, privind raportul calitate/preț, cuprinzand 3 categorii: semi-profesionale, profesionale si industriale.

PROMA-Group are in prezent dealeri in peste 10 tari, inclusiv in Slovacia, Polonia, Lituania, Letonia, Estonia, Romania, Ungaria, Bulgaria si Moldova.

Principalele atuuri ale PROMA-Group sunt experienta de peste 20 ani in productia si distributia de masini-unelte si viziunea asupra dezvoltarii durabile prin extindere regionala in Europa Centrala si de Est



STRUNG UNIVERSAL SPI-3000 | SPI-1500



COD: 25015018 | 25015015

Incepand cu

€28348

Date tehnice	SPI-3000	SPI-1500
Distanța între varfuri	3000 mm	1500 mm
Diametrul max. peste ghidaje batiu	660 mm	
Diametrul max. peste sania transversala	420 mm	
Alezajul arborelui principal	105 mm	
Turatii	36 - 1 600 rot/min	
Numar trepte ax principal	12	
Dimensiuni max. cutit	25 x 25 mm	
Dimensiuni masina	4500 x 1100 x 1450 mm	3000 x 1100 x 1450 mm
Greutate	3920 kg	3565 kg
COD	25015018	25015015
Pret lista	€34,952	€30,892
Pret promotie	€28,500	€28,348

- Capacitate mare de incarcare a arborelui principal
- Lantul cinematic: motor-cutie de viteze-ax principal, robust si precis
- Constructie rigida din fonta de inalta calitate, cu structura nervurata

DOTARE STANDARD

Lampa de iluminat local	Dispozitiv de avans rapid pe 2 axe
Dorn de adaptare	Sistem de racire
Flansa pentru universal 250 mm	Varf fix de fixare
Suport portcutit - 4 pozitii	



STRUNG UNIVERSAL SPF-1500PH

COD: 25015014



Diametru strunjire peste batiu	460 mm
Distanța dintre varfuri	1500 mm
Trecere ax	80 mm
Turatii	25 - 1 800 min.-1 (12 tr.)
Putere motor	4 kW/400 V
Greutate	2750 kg

€17800
€20511



STRUNG UNIVERSAL SPF-1000P

COD: 25015010



Diametru strunjire peste batiu	460 mm
Distanța dintre varfuri	1000 mm
Trecere ax	52 mm
Turatii	40-1800 rot/min. (12 tr.)
Putere motor	4/5,5 kW/400V
Greutate	1850 kg

€14750
€16396



STRUNG UNIVERSAL SPFX-1000P

COD: 25015025



Diametru strunjire peste batiu	460 mm
Distanța dintre varfuri	1000 mm
Trecere ax	82 mm
Turatii	25-2000 rot/min. (12 tr.)
Putere motor	5,5 kW/400V
Greutate	2060 kg

€13600
€15300



STRUNG UNIVERSAL SPE-1000PV

COD: 25015008



Diametru strunjire peste batiu	356 mm
Distanța dintre varfuri	1000 mm
Trecere ax	38 mm
Turatii	45 ÷ 1 800 rot/min. (16tr.)
Putere motor	2,4 kW/400V
Greutate	830 kg

€9655
€10521



STRUNG UNIVERSAL SPEX-1000P

COD: 25015022



€9623
€10486

Diametru strunjire peste batiu	410 mm
Distanta dintre varfuri	1000 mm
Trecere ax	52 mm
Turatii	45 ÷ 1 810 rot/min. (16tr.)
Putere motor	2,2 kW/400V
Greutate	1290 kg



STRUNG UNIVERSAL CU AFISAJ DE COTE SPDx-1000P

COD: 25015021



€5950
€6704

Diametru strunjire peste batiu	400 mm
Distanta dintre varfuri	1000 mm
Trecere ax	52 mm
Turatii	65 ÷ 1 810 rot/min. (16tr.)
Putere motor	2,0 kW/400 V
Greutate	630 kg



STRUNG UNIVERSAL CU AFISAJ DE COTE SPC-900PA

COD: 25015007



€4587
€5096

Diametru strunjire peste batiu	300 mm
Distanta dintre varfuri	830 mm
Trecere ax	38 mm
Turatii	65-1810 rot/min (9 tr)
Putere motor	1,1 kW/400V
Greutate	90 kg



STRUNG PARALEL DE ATELIER SPB-700V/230

COD: 25015027



€3249
€3563

Diametru strunjire peste batiu	305 mm
Distanta dintre varfuri	700 mm
Trecere ax	38 mm
Turatii	100 - 2000 rot/min
Putere motor	1.5 kW / 230 V
Greutate	200 kg



STRUNG PARALEL DE ATELIER SPA-700P

COD: 25000025



€2148
€2407

Diametru strunjire peste batiu	270 mm
Distanta dintre varfuri	700 mm
Trecere ax	25 mm
Turatii	115-1620 rot/min (6 tr.)
Putere motor	0,75 kW/400V
Greutate	150 kg



STRUNG PARALEL DE ATELIER T900I2A/FULL

COD: T900I2A/FULL



€8914
€9551

Diametru strunjire peste batiu	320 mm
Distanta dintre varfuri	830 mm
Trecere ax	38 mm
Turatii	60 ÷ 1600 rot/min
Putere motor	1,5 kW / 230 V
Greutate	500 kg



STRUNG PARALEL DE ATELIER T660I

COD: T660I

Stoc limitat!



€3538
€4776

Diametru strunjire peste batiu	280 mm
Distanta dintre varfuri	660 mm
Trecere ax	26 mm
Turatii	100 ÷ 2000 rpm
Putere motor	0,75 kW/230 V
Greutate	216 kg



STRUNG PARALEL DE ATELIER T700

COD: T700

Stoc limitat!



€3283
€4432

Diametru strunjire peste batiu	290 mm
Distanta dintre varfuri	700 mm
Trecere ax	26 mm
Turatii	(6) 150 ÷ 2000 rpm
Putere motor	1,1 kW/230 V
Greutate	270 kg



STRUNG PARALEL DE ATELIER T900

COD: T900

Stoc limitat!



Diametru strunjire peste batiu	320 mm
Distanta dintre varfuri	900 mm
Trecere ax	38 mm
Turatii	(6) 150 ÷ 2000 rpm
Putere motor	1,5 kW/230 V
Greutate	330 kg

€3167
€4740



MASINA RECTIFICAT ROTUND CU NC AEG-1430NC

COD: AEG-1430NC



Inaltimea la centre	350 mm
Distanta Intre centre	600 mm
Greutate max. piesa	60 mm
Turatie ax	20000 rot/min
Putere motor	3.75 kW/400V
Greutatea	2100 kg

€57500
€64180



CENTRU VERTICAL CNC VMC-450D

COD: VMC-450D



Dimensiuni masa	800 x 260 mm
Greutate maxima masa	200 kg
Cursa axa X/U/Z	450/320/420 mm
Rotatii motor	1 - 8000 rot/min
Putere motor	3,7 kW
Greutate	2400 kg

€38834
€41608



MASINA DE RECTIFICAT PLAN PBP-615

COD: 25012810



Lungimea max. rectificat (axa X)	1700 mm
Latimea max. rectificat (axa Y)	560 mm
Suprafata mesa rectificat	500 x 1600 mm
Dimensiune piatra rectificat	350 x 40 x 127 mm
Putere motor	7.5 KW
Greutatea	6000 kg

€48957
€55269



MASINA DE RECTIFICAT PLAN PBP-400FAI

COD: 25012010



Cursa longitudinala masa	1130 mm
Cursa transversala masa	340 mm
Dimensiuni masa de rectificat	300x1000 mm
Dimensiuni piatra de rectificat	350x40x127 mm
Greutate maxima a piesei	400 kg
Putere motor	4 kW/400V

€28290
€30829



MASINA DE RECTIFICAT PLAN PBP-200FAI

COD: 25012009



Cursa longitudinala masa	510 mm
Cursa transversala masa	238 mm
Dimensiuni masa de rectificat	200x450 mm
Dimensiuni piatra de rectificat	200x20x31,75 mm
Sarcina maxima pe masa	180 kg
Putere motor	2,2 kW/400V

€17680
€19666



MASINA DE RECTIFICAT PLAN PBP-170M

COD: 25012003



Cursa longitudinala masa	340 mm
Cursa transversala masa	170 mm
Dimensiuni masa de rectificat	152x304 mm
Dimensiuni piatra de rectificat	180x13x31,75 mm
Greutate maxima a piesei	30 kg
Putere motor	0,55 kW/230V

€3153
€3458



MASINA DE ALEZAT SI FREZAT ORIZONTALA HBM-110/14

COD: HBM-110/14



Cursa mesei (axa X)	1400 mm
Cursa capului (axa Y)	1200 mm
Cursa mesei (axa Z)	1100 mm
Dimensiuni masa	1100x800 mm
Turatiya arborelu	45-1500 rot/min
Motor arbore principal	7,5 kW/400V
Greutatea	8400 kg

€89600
€103510



MASINA DE FREZAT UNIVERSALA FU-1600

COD: FU-1600



Curse X/Y/Z	1600 /710/710 mm
Con ax	ISO 50
Distanta ax-masa	50-760 mm
Dimensiuni masa	2200 x 540 mm
Sarcina maxima masa	1500 kg
Puterea utila motor	11 kW/400V

€98000
€120920



Proiectata si executata pentru uzinari in regimuri de lucru intensive.

DOTARE STANDARD

Sistem centralizat ungere

Masa deplasabila in cruce

Capetele frezare orizontale, universale

Sistem de racire pompa

Motorizari pe toate directiile de lucru



MASINA DE FREZAT METALE CU AFISAJ DE COTE F060I

COD: F060I



Frezare frontala max.	Ø 100 mm
Frezare cilindrica max.	Ø 35 mm
Con ax	ISO 40
Cursa ax	127 mm
Dimensiuni masa	1246 x 230 mm
Turatii	60 - 3600 rot/min
Putere motor principal	2,25 kW / 400 V
Greutate	1000 kg

€16576
€17760



Masina se adreseaza productiei de serie mica si unicate, de complexitate medie

DOTARE STANDARD

Structura turnata din fonta

Afisaj de cote 3 axe

Motor cu invertor



MASINA DE FREZAT METALE CU AFISAJ DE COTE FVW-125PD

COD: 25330125



Diametru max. frezare orizontala	125 mm
Diametru max. frezare verticala	28 mm
Con ax	ISO 40
Distanta ax-masa	0-440 mm
Dimensiuni masa	1120 x 260 mm
Turatii	40-1600 rot/min
Putere motor	2,20 kW/400V

€14750
€15459



MASINA DE FREZAT METALE CU AFISAJ DE COTE FNS-55PD

COD: 25006325



Diametru max. frezare	60 mm
Diametru max. gaurire	45 mm
Con ax	ISO 40
Distanta ax-masa	0-405 mm
Dimensiuni masa	1370x250 mm
Turatii	65-4500 rot/min
Putere motor	2,25 kW/400V

€12652
€13787



MASINA DE FREZAT METALE CU AFISAJ DE COTE FHV-50PD/2

COD: 25000068

Stoc limitat!



Diametru max. frezare	100 mm
Diametru max. gaurire	50 mm
Con ax	ISO 40
Distanta ax-masa	65 - 365 mm
Dimensiuni masa	1000 x 240 mm
Turatii	60-1350 rot/min
Puterea utila motor	1,5 kW/400V

€8486
€9429



MASINA DE FREZAT METALE CU AFISAJ DE COTE FP-48SPN

COD: 25014001



BEST SELLER



Diametru max. frezare	32 mm
Diametru max. gaurire	45 mm
Conul ax	Mk IV
Distanta ax-masa	500 mm
Dimensiuni masa	800 x 240 mm
Turatii	80-1250 rot/min
Putere motor	1,5 kW/400V

€4474
€4971



MASINA DE FREZAT METALE DE BANC FP-45P

COD: 25330045

PROMA



Diametru max. frezare	32 mm
Diametru max. gaurire	45 mm
Conul ax	Mk IV
Distanta ax-masa	450 mm
Dimensiuni masa	800 x 240 mm
Turatii	80÷1250 rot/min
Putere motor	1,5 kW/400V

€2588
~~€2911~~



MASINA DE FREZAT METALE DE BANC FP-25VA

COD: 25014005

PROMA



Diametru max. frezare	25 mm
Conul ax	Mk III
Distanta ax-masa	325 mm
Dimensiuni masa	690 x 180 mm
Turatii	100-2250 rot/min
Putere motor	0,75 kW/400V

€1950
~~€2310~~



MASINA DE GAURIT, FREZAT SI FILETAT T047/400V

COD: T047/400V

FERVI



- Capul este inclanabil $\pm 60^\circ$
- Permite frezare, gaurire si filitare
- Pentru ateliere de intretinere si mica productie

DOTARE STANDARD

Mandrina rapida 1-16 B16

Mandrina cu cheie MT4 B16

Reductii MT 4/3, MT 3/2

Diametru max. frezare	40 mm
Diametru max. gaurire	32 mm
Conul ax	CM 4
Canal T	12 mm
Diametru de filetare	22 mm
Dimensiuni masa	585 x 190 mm
Turatii	75-3200 rot/min
Putere motor	1,5 kW/400V

€3900
~~€4359~~



MASINA DE FREZAT SI GAURIT T044/400V

COD: T044/400V

FERVI



Diametru max. gaurire (Fonta)	45 mm
Diametru max. gaurire (Otel)	32 mm
Diametru max. freza frontala	45 mm
Conul ax	CM 4
Dimensiuni masa	800 x 240 mm
Viteze de lucru	95 - 1600 rot/min
Putere motor	1,5 kW/400V

€3543
~~€3861~~



MASINA DE FREZAT SI GAURIT T058

COD: T058

FERVI



Diametru max. frezare	16 mm
Diametru max. gaurire	13 mm
Conul ax	CM 3
Distanta ax-masa	290 mm
Dimensiuni masa	430 x 110 mm
Turatii	150 ÷ 1100 rot/min
Putere motor	0,55 kW/230V

€1395
~~€1593~~



MASINA DE GAURIT STATIONARA CU AVANS AUTOMAT S-1850FP/400

COD: 25004036

PROMA



- Se adreseaza productiei industriale
- Posibilitatea de gauri perpendiculare / inclinate fata de suprafata mesei
- Posibilitate de filetare

DOTARE STANDARD

Rotire masa 360°

Inclinare masa $\pm 45^\circ$

Afisaj turatii

Afisaj digital avans

Instalatie de racire

Deplasare masa manuala+mecanica

Limitator ax

Lampa de lucru

Capacitate max. gaurire	50 mm
Capacitate filetare	M30
Con ax	Mk IV
Dimensiuni masa	600x500 mm
Turatii	52-1400 rot/min
Putere motor	2.2 kW/400V
Greutate	572 kg

€6872
~~€7398~~



MASINA DE GAURIT STATIONARA CU AVANS AUTOMAT P-1850/400

COD: P-1850/400



Capacitate max. gaurire otel	50 mm
Capacitate filetare	M30
Con ax	Mk V
Dimensiuni masa	550x470 mm
Turatii	42-2050 rot/min
Putere motor	3 kW/400V
Greutate	750 kg

Stoc limitat!

€7984

€9208



MASINA DE GAURIT STATIONARA CU AVANS AUTOMAT T066

COD: T066



Capacitate max. gaurire	40 mm
Con ax	MT 4
Dimensiuni masa	500 x 380 mm
Turatii	75 ÷ 3200 rot/min
Putere motor	1,1-1,5 kW
Greutate	400 kg

€4900

€5486



MASINA DE GAURIT STATIONARA CU AVANS AUTOMAT T032

COD: T032



Capacitate max. gaurire	31,75 mm
Con ax	Mk 3
Dimensiuni masa	330 x 380 mm
Turatii	160 - 1880 rot/min
Putere motor	1,5 kW/400V
Greutate	280 kg

Stoc limitat!

€2831

€3145



MASINA DE GAURIT CU COLOANA, STATIONARA T062

COD: T062



Capacitate max. gaurire	40 mm
Con ax	MT 4
Dimensiuni masa	500 x 380 mm
Turatii	75-3200 rot/min
Putere motor	1,5 kW/400V
Greutate	350 kg

Stoc limitat!

€4217

€4596



MASINA DE GAURIT CU COLOANA, STATIONARA 0252/400V

COD: 0252/400V



Capacitate max. gaurire	32 mm
Con ax	CM / MT 4
Dimensiuni masa	460 x 425 mm
Turatii	150 ÷ 2450 rot/min
Putere motor	1,5 kW/400V
Greutate	135 kg

€1581

€1757



MASINA DE GAURIT CU COLOANA, STATIONARA E-2020F/400

COD: 25402001



Capacitate max. gaurire	32 mm
Con ax	Mk IV
Dimensiuni masa	425x475 mm
Turatii	120 -3480 rot/min
Putere motor	1,5 kW/400V
Greutate	119 kg

€780

€919



MASINA DE GAURIT CU COLOANA, STATIONARA BV-25B/400

COD: 25004125



Capacitate max. gaurire	25 mm
Con ax	Mk III
Dimensiuni masa	280 x 300 mm
Turatii	365-3150 rot/min
Putere motor	1,1 kW/400V
Greutate	140 kg

€856

€959



MASINA DE GAURIT SI FILETAT CU COLOANA BZ-25B/400

COD: 25004128



Capacitate max. gaurire	25 mm
Diametru max. filetare	M14
Con ax	Mk III
Dimensiuni masa	280 x 300 mm
Turatii	290-2150 rot/min
Putere motor	1,1 kW/400V

€1071

€1200



MASINA DE GAURIT CU COLOANA, STATIONARA E-1720/400

COD: 25401702



Capacitate max. gaurire	25 mm
Con ax	Mk III
Dimensiuni masa	350 x 355 mm
Turatii	180 - 3000 rot/min
Putere motor	1,1 kW/400V
Greutate	77 kg

€556
€639

Livrare imediata din stoc



MASINA DE GAURIT CU COLOANA, STATIONARA 0857

COD: 0857



Capacitate max. gaurire fonta	20 mm
Con ax	Mk II
Dimensiuni masa	ø 290 mm
Turatii	(12) 300 ÷ 2550 rpm
Putere motor	0,375 kW/230V
Greutate	60 kg

€752
€847



MASINA DE GAURIT CU COLOANA STATIONARA E-1516B/400 | E-1516B/230

COD: 25401501 | 25231501

Livrare imediata din stoc



BEST SELLER

• Raportul pret-calitate le recomanda pentru atelierele mecanice si scolile profesionale

DOTARE STANDARD

Limitator adancime reglabil	Lampa de lucru
Rotire masa	Lagaruire ax principal cu rulmenti

Inceput cu
€438



Date tehnice	E-1516B/400	E-1516B/230
Capacitate max. gaurire	20 mm	
Con ax	Mk II	
Dimensiuni masa	300x300 mm	
Turatii	180-2740 rot/min	
Putere motor	0,75 kW/400V	0,75 kW/230V
Greutate	58 kg	
COD	25401501	25231501
Pret lista	€519.00	€513.00
Pret promotie	€438.00	€448.00

MASINA DE GAURIT CU COLOANA, STATIONARA B-1316F/230

COD: 25401304



Capacitate max. gaurire	20 mm
Con ax	Mk II
Dimensiuni masa	254 x 254 mm
Turatii	180 - 2740 rot/min
Putere motor	0,6 W/230V
Greutate	58 kg

€382
€453

Stoc limitat!



MASINA DE GAURIT CU COLOANA, STATIONARA B-1316B/400

COD: 25401303



Capacitate max. gaurire	16 mm
Con ax	Mk II
Dimensiuni masa	ø 310 mm
Turatii	180 - 2740 rot/min
Putere motor	0,6 W/400V
Greutate	53 kg

€432
€497



MASINA DE GAURIT CU COLOANA, STATIONARA PTB-16B/230

COD: 25333520



- ✓ Raport pret-calitate excelent
- ✓ Pentru atelierele mecanice si scolile profesionale.

DOTARE STANDARD

Limitator de adancime
Inclinare masa ± 45°
Lagaruire ax principal cu rulmenti radiali

Capacitate max. gaurire	16 mm
Con ax	Mk II
Dimensiuni masa	195 x 195 mm
Turatii	210 -2580 rot/min
Putere motor	0,45 W/230V
Greutate	34 kg

Livrare imediata din stoc

€348

€395



MASINA DE GAURIT RADIALA FRD-2000H

COD: FRD-2000H



Capacitate max. gaurire	85 mm
Con ax principal	MT 6
Dimensiuni masa	850 x 540 mm
Cursa ax	300 mm
Viteza ax	20 - 1300 rot/min.
Putere motor	7,5 kW/400V
Greutate	8000 kg

€67715
€70199



MASINA DE GAURIT RADIALA TRP-2000H

COD: TPR-2000H

Prindere hidraulica



Capacitate max. gaurire	70 mm
Con ax principal	MT#5
Dimensiuni masa	1000x800x500 mm
Cursa ax	370 mm
Viteza ax	35-1890 rot / min (12 tr)
Putere motor	5.5 kW
Greutate	5600 kg

€53800
€61036



MASINA DE GAURIT RADIALA TC-1250H

COD: TC-1250H



Capacitate max. gaurire	60 mm
Con ax principal	MT#5
Dimensiuni masa	635x520x420 mm
Cursa ax	270 mm
Viteza ax	56-1450 rot / min (12 tr)
Putere motor	3.75 kW
Greutate	2300 kg

€23250
€24103

Prindere hidraulica



MASINA DE GAURIT RADIALA TR01/180

COD: TR01/180



Capacitate max. gaurire (fonta)	40 mm
Con ax principal	MT4
Dimensiuni masa	550 x 390 x 350 mm
Cursa ax	220 mm
Viteza ax	76-1220 rot/min (6 tr.)
Putere motor	1,5 kW/400 V
Greutate	1050 kg

€9549
€10231



MASINA DE GAURIT RADIALA RV-50E | RV-40E

COD: 25013006 | 25013007



Incepand cu
€11600

Date tehnice	RV-50E	RV-40E
Capacitate max. gaurire	50 mm	40 mm
Dimensiuni masa	630 x 500 x 500 mm	450 x 450 x 500 mm
Con ax principal	Mk V / Mk IV	Mk IV
Cursa ax	315 mm	250 mm
Viteza ax	25-2000 rot/min. (16 tr.)	50-1035 rot/min. (9 tr.)
Putere motor	4 kW/400V	3 kW/400V
COD	25013006	25013007
Pret lista	€17,432	€11,872
Pret promotie	€16,456	€11,600

- ✓ Ideale pentru gaurire, alezare, zencuire si filetare
- ✓ Canale T pe placa de baza si masa

DOTARE STANDARD

Lampa de iluminat local, cu halogen

Sistem de racire



MASINA DE GAURIT RADIALA RV-32

COD: 25030327



Capacitate max. gaurire	32 mm
Diametrul max. letare	M 22
Dimensiuni masa	250x250x250 mm
Conul ax principal	Mk III
Turatii	100-1600 rot/min (8 tr.)
Putere motor	1,1 kW/400V
Greutate	580 kg

€3525
€3866



MASINA DE GAURIT RADIALA 0757

COD: 0757



Capacitate max. gaurire fonta	16 mm
Dimensiuni masa	Ø 290 mm
Conul ax principal	Mk II
Turatii	500 ÷ 2450 rot/min (5 tr.)
Putere motor	0.375 kW/400V
Greutate	46 kg
Greutate	380 kg

€653
€735



MASINA DE GAURIT CU TALPA MAGNETICA RU40 | RU25



Incepand cu
€1468

Date tehnice	RU40	RU25
Fora magnetului:	20000 N	16000 N
Diametru max. carota	80 mm	50 mm
Diametru max. mandrina	16 mm	16 mm
Diametru max. burghiu	32 mm	20 mm
Consum curent	1.8 kW/230V	1.2 kW/230V
Greutate:	22 kg	16 kg
COD	108040RU	108025RU
Pret lista	€2,152	€1,781
Pret promotie	€1,860	€1,468



Filetare



COD: 108040RU | 108025RU

DOTARE STANDARD Sticla racire + suport
Instructiuni utilizare

Adaptor con MT3/B16 Ulei pentru taiere

Cutie de transport Mandrina 3 - 16 mm



Stoc limitat!

MASINA DE GAURIT CU TALPA MAGNETICA 0518/80 | 0518/50 | 0518/30 | 0518/20



Incepand cu
€599



Date tehnice	0518/80	0518/50	0518/30	0518/20
Fora magnet	20000 N	15000 N	11000 N	8500 N
Capacitate max. carota	80 mm	50 mm	30 mm	20 mm
Diametru max. mandrina	19 mm	16 mm	16 mm	13 mm
Capacitate max. burghiu	20 mm	20 mm	20 mm	20 mm
Putere motor	1.8 kW/230 V	1.5 kW/230V	1.1 kW/230V	0.9 kW/230V
Greutate bruta	35 kg	35 kg	23 kg	15 kg
Pret lista	€1876	€1,417	€1,049	€808
Pret promotie	€1689	€1,380	€944	€599

Stoc limitat!

Stoc limitat!



MASINA DE MORTEZAT METALE S315D



COD: S315D



DOTARE STANDARD	Display cu ecran tactil cu PLC	Mortezare: canale piese masini, canale ortogonale si in evoluta, roti dintate, suprafete plane
Ciclu automat complet	Sistem de racire	
Control manual cu joystick + avans rapid	Afisaj digital pentru masa rotativa	Accesorii Standard: trusa de scule, Lampa de iluminat Instructiuni de utilizare
Sistem automat de lubrifiere	Set de scule	

€29884
€35131

Traseu brosa	0 - 315 mm
Curse	14-60
Cursa berbec	235 mm
Inclinare cap brosa	± 45 °
Putere motor	4 kW/400V
Greutate	1310 kg



MASINA DE MORTEZAT METALE S200TGI



COD: S200TGI



Mortezare: canale piese masini, canale ortogonale si in evoluta, roti dintate, suprafete plane

DOTARE STANDARD	
Oprire automata scule	Cruse duble / min reglabile
Afisaj curse duble / min	Ciclu semi-automat al avansului transversal

Accesorii Standard: trusa de scule, Lampa de iluminat Instructiuni de utilizare

Traseu brosa	0 - 200 mm
Curse	17 - 60
Cursa berbec	210 mm
Inclinare cap brosa	± 45 °
Putere motor	4 kW
Greutate	875 kg



MASINA DE BROSAT METALE BM25

COD: 100-09-01-001

NARGESA®



€11850
€14073

- Brose in mililetrii si inci, diferite tolerante: ISO J-9, ISO P-9.
- Se pot realiza un numar multiplu de canale pe aceeasi gaura si caneluri interne.

Frme piese:

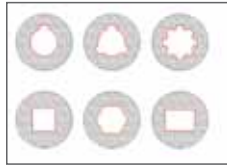

Putere hidraulica	10 t
Traseu brosa	600 mm
Diametru gat	300 mm
Dimensiuni masa lucru	420x420 mm
Putere motor	2,2 kW
Greutate	850 Kg



POLIZOR DE BANC CU DOUA DISCURI SEA-10 POLIZOR CU STATIV SI ASPIRATOR SEA-9

COD: SEA-10 | SEA-9

NEBES



Incepand cu
€741



Stoc limitat!

- Pentru uz industrial
- Protectie termica motor
- Aparatori scantei

Date tehnice	SEA-10	SEA-9
Dimensiuni disc	200x25x20 mm	150x20x16 mm
Putere motor	0,75 kW/400V	0,375 kW/400V
Turatii	2800 rpm	2800 rpm
Greutate	58 kg	43 kg
COD	SEA-10	SEA-9
Pret lista	€1,374	€1,206
Pret promotie	€1,090	€741



POLIZOR DE BANC CU DOUA DISCURI S-5

COD: S-5

NEBES



- Structura din fonta

Dimensiuni disc	300x35x30 mm
Putere	1800 W
Turatii	1400 rot/min
Greutate	64,5 kg

€1120
€1371



POLIZOR DE BANC CU DOUA DISCURI S-200T

COD: S-200T

NEBES



Dimensiuni disc	200 x 25 x 16 mm
Putere motor	0,75 kW/400V
Turatii	2800 rot/min
Greutate	17,6 kg

€323
€395



POLIZOR DE BANC CU DOUA DISCURI S-200M

COD: S-200M

NEBES



Dimensiuni disc	200 x 25 x 16 mm
Putere motor	0,675 kW/400V
Turatii	2800 rot/min
Greutate	17,6 kg

€300
€367



POLIZOR DE BANC CU DOUA DISCURI 0552/400V

COD: 0552/400V

FERVI



Dimensiuni disc	200 x 25 x 20 mm
Putere motor	0.9 kW/380 V
Turatii	2950 rot/min
Greutate	25 kg

€279
€324



POLIZOR DE BANC CU DOUA DISCURI BKS-2500

COD: 25002502



Dimensiuni disc	250x32x32 mm
Putere motor	1,1 kW/400V
Turatii	2950 rpm
Greutate	35,5 kg

- Protectie antiscantei din plexiglas
- Gauri pentru fixarea pe masa
- Raport performanta-pret excelent

€258
~~€317~~

Livrare imediata
din stoc



POLIZOR DE BANC CU DOUA DISCURI BKN-1500

COD: 25006405



Diametru disc	150x102x25 mm
Putere motor	0,55kW / 230V
Turatie disc	2950 rot/min
Canal	12 mm
Dimensiuni masa	170 x 304 mm
Greutate	43kg

€328
~~€388~~



POLIZOR DE BANC CU DOUA DISCURI BKL-2000

COD: 25450200



Dimensiuni disc	200x25x16 mm
	200x40x16 mm
Putere motor	0,55 kW/230V
Turatii	2850 rot/min
Greutate	20 kg

€178
~~€211~~

Livrare imediata
din stoc



POLIZOR DE BANC CU DOUA DISCURI BKL-1500

COD: 25450150



Dimensiuni disc	150x25x12,7 mm
	150x40x12,7 mm
Putere motor	0,375 kW/230V
Turatii	2850 rot/min
Greutate	11,5 kg

€107
~~€127~~

Livrare imediata
din stoc



POLIZOR DE BANC CU DOUA DISCURI 0023

COD: 0023



Dimensiuni disc	150x20x12,7 mm
Putere motor	0,35 kW/230V
Turatii	2950 rot/min
Greutate	7,8 kg

€91.62
~~€104~~

Livrare imediata
din stoc



POLIZOR DE BANC COMBINAT CU PERIE SI DISC CA-5

COD: CA-5



- Polizor industrial puternic care este dotat cu aspirator cu ventilator din aluminiu
- La asamblare aspiratorul este echilibrat cu stroboscopul pentru a elimina vibratiile si zgomotul

Dimensiuni disc	300x35x30 mm
Perie	300x35x25 mm
Putere motor	1,8 kW/230V
Turatii	1400 rot/min
Greutate	125kg

€2194
~~€2686~~



POLIZOR DE BANC COMBINAT CU PERIE SI DISC 0554/400V | 0554/220V

COD: 0554/400V | 0554



Stoc limitat!

Incepend cu
€257

Date tehnice	0554/400V	0554
Dimensiuni perie	200 x 25 x 20 mm	
Dimensiuni disc	200 x 25 x 20 mm	
Putere motor	0.9 kW/380V	0.9 kW/230V
Turatii	2950 rpm	
Greutate	30 kg	
COD	0554/400V	0554
Pret lista	€ 350	€ 350
Pret promotie	€ 257	€ 296



POLIZOR DE BANC CU DOUA DISCURI 0552/220V

COD: 0552



Dimensiuni disc	200x25x20 mm
Putere motor	0.9 kW/230 V
Turatii	2950 rot/min
Greutate	27 kg

€285
~~€350~~



POLIZOR DE BANC COMBINAT CU PERIE SI DISC 0556

COD: 0556



Dimensiuni perie	200 x 25 x 20 mm
Dimensiuni disc	200 x 25 x 20 mm
Putere motor	0.75 kW/230V
Turatii	2950 rpm
Greutate	22 kg

Livrare imediata din stoc

€206
~~€236~~



POLIZOR DE BANC COMBINAT CU PERIE SI DISC 0553

COD: 0553



Perie	Ø 150 x 20 x 16 mm
Disc	Ø 150 x 20 x 16 mm GR36
Greutate	16 kg
Turatii disc umed	130 rpm
Putere motor	0,52kW/ 230V

Livrare imediata din stoc

€159
~~€209~~



POLIZOR DE BANC COMBINAT CU BANDA SI DISC BKLP-1500

COD: 25016005



Dimensiuni disc	150 x 20 x 12,7 mm
Dimensiuni banda	50 x 686 mm
Putere motor	0,35 kW/230V
Turatii	2850 rot/min
Greutate	10,3 kg

Livrare imediata din stoc

€129
~~€152~~



POLIZOR DE BANC COMBINAT CU PERIE SI DISC MBKL-1500L

COD: 25012004



DOTARE STANDARD	Suport rigid material
Dispozitiv ascutire disc	Dispozitiv de fixare pe suport
Funcionare lina	Spatiu pentru racire

Dimensiuni perie	150 x 20 x 12,7 mm
Dimensiuni disc	150 x 12 x 12,7 mm
Putere motor	0,375 kW/230V
Turatii	2850 rpm
Greutate	10,3 kg

€125
~~€148~~



POLIZOR DE BANC COMBINAT CU DISC SI BANDA SLP-4

COD: SLP-4



€1895
€2321

Standul nu este inclus.

- Permite indepartarea bavurilor, rotunjire muchii taioase
- Slefuire si debavurare piese de turnatorie: aluminiu, fonta, alama, bronz etc.
- La asamblare aspiratorul este echilibrat cu stroboscopul pentru a elimina vibratiile si zgomotul

Putere motor	1500 W
Turatii	1400 / 2800 rpm
Dimensiuni banda	2000x50 mm
Diametru perie	250 mm
Dimensiuni masina	120x80x135 mm
Greutate	106 kg



POLIZOR DE BANC COMBINAT CU DISC SI BANDA S383

COD: S383



€139
€161

Dimensiuni disc	150 x 20 x 16 mm
Dimensiuni banda	50 x 686 mm
Putere motor	0,40 kW/ 230V
Turatii	2950 rot/min
Greutate	8 kg



POLIZOR COMBINAT UMED, USCAT 0377

COD: 0377



€213
€255

Dimensiuni disc umed	Ø 200x40x20 mm
Dimensiuni disc uscat	Ø 150x20x16 mm
Turatii disc umed	130 rpm
Turatii disc uscat	2950 rpm
Putere utila	0,52 kW/230 V

Stoc limitat!



POLIZOR COMBINAT UMED, USCAT S503

COD: S503



€131
€155

Dimensiuni disc umed	Ø 200x40x20 mm
Dimensiuni disc uscat	Ø 150x20x12,7 mm
Turatii disc umed	130 rpm
Turatii disc uscat	2950 rpm
Putere utila	0,40 kW /230 V

Stoc limitat!



POLIZOR COMBINAT UMED, USCAT 0503

COD: 0503



€94.48
€107

Dimensiuni disc umed	Ø 200x40x20 mm
Dimensiuni disc uscat	Ø 150x20x12,7 mm
Turatii disc umed	130 rpm
Turatii disc uscat	2950 rpm
Putere utila	0,35 kW/ 230V



MASINA DE ASCUTIT LANT DRUJBA 0316

COD: 0316



€155
€176

Diametru piatra	145 x 3,2 x 22,3 mm
Unghi ascutire	+30° / -35°
Pentru lanturi	1/4" - 3/8" - 3/8" - 404" - 3/4"
Putere motor	0,23 kW/230V
Greutate	5 kg



MASINA DE ASCUTIT LANT DRUJBA 0502

COD: 0502



€68.86
€86.19

Diametru piatra	100 x 4,5 x 10 mm
Unghi ascutire	+35° / -35°
Pentru lanturi	1/4" - 0,325" / 3/8" - 0,404"
Putere motor	0,25 kW/230V
Greutate	1,8 kg

Stoc limitat!



MASINA DE ASCUTIT SCULE BSG 60

COD: 11323



€6052
€7115



Kaindl
SCHLEIFTECHNIK



Capacitate acutire	Ø 3- 40 mm
Dimensiuni piatra	200 x 40 x 51 mm
Putere motor	230 V, 50 Hz, 0,37 kW
Turatii	2840 rpm-1
Greutate	57 kg
Dimensiuni	570 x 330 x 520 mm

- Dispozitivul primastic de fixare asigura acutire precisa si simetrica
- Ascute toate tipurile de burghie (inclusiv forme speciale), burghie in trepte, burghie tabla, burghie lemn
- Cutite frezare din HSS si Widia

Echipeamente	Manivela	
Dispozitiv prismatic de fixare 3 - 40 mm	Piatra Ø 200 mm, granulatatie 60	Lupa de precizie cu sistem iluminare
Dispozitiv de acutire cutite si zencuitoare	Dispozitiv reascutire piatra rectificat cu diamant	Suport talpa din granit
Set 7 pensete colectoare	Manual in format DVD	Adaptor pentru aspirator Ø 32 mm



MASINA DE ASCUTIT BURGHIE BSG 20/2

COD: 17651



€1475
€1620

- ✓ Permite acutirea burghiilor speciale:
 - burghie in trepte,
 - burghie pentru tabla,
 - burghie pentru lemn
- ✓ Asigura simetrie inalta de acutire
- ✓ Constructie compacta, usor de manipulat si utilizat

Echipeamente
Piatra Ø 125 mm, granulatatie 80
Dispozitiv reascutire piatra rectificat cu diamant
Lupa de lucru

Capacitate prindere	Ø 2 - 20 mm
Dimensiune disc	125 x 20 x 20 x 75 mm
Turatii	2840 rpm
Putere motor	0,12kW/230V
Greutate	13,5 kg
Dimensiuni	290 x 220 x 250 mm

Kaindl
SCHLEIFTECHNIK



MASINA DE ASCUTIT BURGHIE A0132A

COD: A0132A

FERVI



Dimensiunile burghiului	3 - 20 mm
Unghiuri de lucru	90° ÷ 140°
Turatii	7000 rpm
Putere motor	0,6 kW/230V
Greutate	21 kg

€1061
€1179



MASINA DE ASCUTIT PANZE CIRCULARE OPK-700

COD: 25000700

PROMA



Stoc limitat!

Diametru disc diamantat	125 x 10 x 32 mm
Diametru disc acutit	80 - 700 mm
Rotire disc acutit:	-30°, +45°
Turatii	2800 rot/min
Putere motor	0,37 kW/230V

€236
€283



MASINA DE DEBAVURAT SI SLEFUIT STEEL LINE 240 BSM 1600 RDB | STEEL LINE 180 BSM 1100 RDB STEEL LINE 120 BSM 650 RD



APLICATII



(R) Debavurat si slefuit



(B) Lustruire finala suprafete



(D) Rotunjire muchii, bavuri, indepartare oxizi

Date tehnice	STEEL LINE 240 BSM 1600 RDB	STEEL LINE 180 BSM 1100 RDB	STEEL LINE 120 BSM 650 RD
Panou de control tactil	Schneider 10,4"	Schneider 10,4"	Schneider 7,5"
Masa	l = 800 mm – vacuum, ventilata	l = 500 mm	l = 500 mm
Masurare automata a piesei	da	da	da
Lungime banda de slefuit	2200 mm	1900 mm	1900 mm
Latime de lucru	1600 mm	1100 mm	650 mm
Inaltime min / max piesa	0.5 / 160 mm	0.5 / 160 mm	0.5 / 125 mm
(R) Unitate debavurare si slefuit	Ø 240 mm (15 kW)	Ø 180 mm (11 kW)	Ø 120 mm (7,5 kW)
(D) Unitate rotunjire, indepartare oxizi	165 mm (CW& CCW) (7,5 kW)	165 mm (CW& CCW) (5,5 kW)	165 mm (CW& CCW) (5,5 kW)
(B) Unitate finsare Verbax	Ø 300 mm (7,5 kW)	Ø 200 mm (5,5 kW)	-
COD	SERIES240BSM1600RDB	SERIES180BSM1100RDB	SERIES120BSM650RD
Pret lista	€ 141794	€ 75338	€ 52033
Pret promotie	€ 134217	€ 67000	€ 49252

Inceand cu

€ 49252



MASINA CNC DE DEBITAT CU FIR PRIN ELECTROEROZIUNE IN 5 AXE WI-430S

COD: 1810087



€ 78700

€ 85988

DOTARE STANDARD

1. Fir ghidare Ø 0.25 mm
2. Fir Ø 0.25 mm / 5 kg
3. Bazin apa
4. Telecomanda
5. Scule montaj
6. Filtre (2 buc/set)
7. rasina schimbatoare de ioni (5 L)
8. Duza apa
9. Dispozitiv ghidare verticala auto
10. Contact avans (2 buc/set)
11. Scule prindere
12. Ecran tactil 15" LCD



Dimensiuni max. piesa	700 x 540 x 295 mm
Dimensiuni masa de lucru	640 x 500 mm
Greutate max. a piesei	500 kg
Axe de lucru simultane	X/Y/U/V (4 axe)
Diametru fir	Ø 0.1~0.3 (mm)
Viteza max. taiere	≤ 200mm ² /min
Greutate masina	2100 kg



MASINA ELECTROEROZIUNE CU ELECTROD MASIV CNC-EB600L

COD: CNC-EB600L



€ 43103

€ 44684

Volum lucru	1100x600x400 mm
Dimensiuni masa	700x400 mm
Greutate max. piesa	1500 kg
Axe de lucru	400 / 300 / 300 mm
Volum rezervor	370 l
Putere max.	7 kVA
Greutate	2000 kg



MASINA ELECTROEROZIUNE CU ELECTROD MASIV AD-30

COD: AD-30



€ 26214

€ 27176

Dimensiuni piesa	875 x 470 mm
Dimensiuni masa	600 x 300 mm
Greutate max. piesa	400 kg
Curse axele X / Y	350 mm / 250 mm
Capacitate dielectric	20 l
Putere max.	4 kVA
Greutate	800 kg



MASINA DE GAURIT SI FILETAT ELECTRICA DRILLTRONIC M3 - M20 DTS161250

COD: DTS161250



Structura masinii este proiectata pentru a asigura pozitionari rapide si usoare, asigurand rigiditate si precizie.

€16300
€17590



Aria de lucru	2600 x 1600 mm
Capacitate filetare in otel	M3 - M20
Capacitate gaurire	3 - 16 mm
Cursa verticala	500 mm
Cursa	135 mm
Turatii nominale	30 - 1250 rpm



MASINA DE FILETAT ELECTRICA CU BRAT TRIPLU ARTICULAT JOYTAP 3 M5-M24 | JOYTAP 3 M8-M36 | JOYTAP 3 M8-M36



- ✓ Structura din aluminiu care ofera rigiditate si precizie ridicata
- ✓ Mecanica bratului articulata dezvoltata pentru fluiditate si rezistenta
- ✓ Motoare fara perii (G2) cu performanta si fiabilitate de neegalat
- ✓ Protectie termica sistem de cabluri
- ✓ Consum scazut de curent
- ✓ Nivel scazut de zgomot

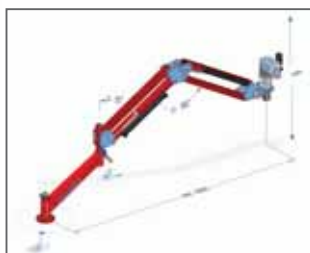

Aria de lucru 2000 mm



Cap de lucru multidirectional pentru JT-3750M



Reglare continua viteza lucru

Incepand cu
€4990



Stoc limitat!

Date tehnice	JOYTAP 3 M8-M36	JOYTAP 3 M8-M36	JOYTAP 3 M5-M24
Capacitate de filetare in otel	M8 - M36	M8 - M36	M5 - M24
Mandrina	GR3	GR3	GR2
Turatii nominale	20-145 rpm	20-145 rpm	20 - 200 rpm
Aria de lucru	1900 mm	1900 mm	1900 mm
Greutate	25 kg	25 kg	20 kg
COD	JT-3750M	JT3750	JT3500
Pret lista	€7381	€6734	€5385
Pret promotie	€6840	€6240	€4990



MASINA DE FILETAT ELECTRICA CU BRAT DUBLU ARTICULAT JOYTAP 2 M3 - M16

COD: JT2150



€4021
€4339

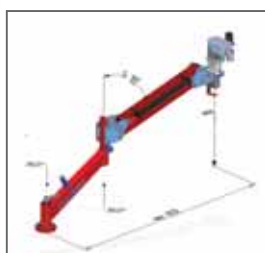

Aria de lucru 1370 mm



Cap de lucru multidirectional



Capacitate de filetare in otel	M3 - M16
Mandrina	GR2
Turatii nominale	50-500 rpm
Aria de lucru	1370 mm
Greutate	15 kg



MASINA DE FILETAT ELECTRICA CU BRAT DUBLU ARTICULAT SNIPER400 M2 - M14

COD: SNP400



Capacitate de filetare in otel	M5 - M16
Mandrina	GR2
Viteza nominala	40 - 450 rpm
Aria de lucru	1100 mm
Greutate	20 kg

€3337
€3602



MASINA DE FILETAT CU BRAT ARTICULAT HIDRAULICA HUK2000RH (M5-M24)

COD: HUK2000RHM5M24



Capacitate filetare	M5 - M24
Dimensiuni masa	700x900x900 mm
Turatii nominale	1: 0-600 rpm ; 2: 0-150 rpm
Aria de lucru	2050 mm
Putere motor	2.2 kW/380 V
Greutate	225 kg

€3962
€4379



MASINA DE FILETAT PNEUMATICA CU BRAT ARTICULAT AT 27/II M3-M27

COD: 013000010327



Capacitate de filetare	M3 - M27
Turatii nominale	70 / 220 rpm
Aria de lucru	200 - 1900 mm
Greutate	38 kg

€2991
€3326



BRAT TRIPLU ARTICULAT COMPENSARE CU ATASAMENT ORBITAL TIP C EASYARM 5.5-8 KG

COD: EA195010+EA-OB-C



Forta strangere	180 Nm
Greutate sustinuta	5.5-8kg
Aria de lucru	1900 mm
Atasament orbital tip C	130mm
Greutate brat:	17 kg

Stoc limitat!

€2570
€3886



MANIPULATOR PIESE LUCRU CU SUPTOR MOBIL SI CAP PRINDERE CU VACUUM RM02+RM.TM07.A01+MV074V0815015+CSM001

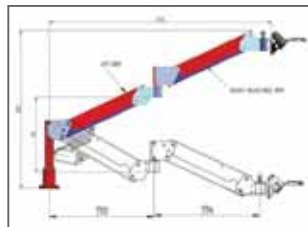

Permite ridicarea, miscarea si rotirea de piese in hala dvs. de productie

DOTARE STANDARD

Dispozitiv de prindere in 4 puncte cu vacuum MV074V0815015

Stand mobil 800X800mm pentru manipulator CSM001

Cap motorizat RM.TM07.A01

Capacitate ridicare	1-50 kg
Rotire	360°
Cursa verticala:	736 mm
Cap cu rotire pneumatica	0°-50°
Sistem prindere pneumatic	4 vacuum Ø 150mm
Capacitate totala prindere	180kg
Suport manipulator cu roti:	800X800 mm

€13752
€14840



MASINA DE FILETAT ELECTRICA ZPM-50

COD: 25000050



Capacitate filetarii tevii	1/2" - 2"
Diametru filetare metric	M8-M24
Turatii universal filetare	27 rpm
Putere motor	0,75 kW/230V
Greutatea	65 kg

Stoc limitat!

€990
€1222



MASINA ELECTRICA DE FILETAT TEVI 392-L - 400V/50Hz | 392-L

COD: 9400080 | 0001440



Capacitate filetare	1/4"-2" (39 mm)
Turatii nominale	2830/1400 rpm
Cursa menghina	270 mm
Dimensiuni	770x640x550 mm
Greutate	175 kg

€8509
€8957

+ Optional carucior €623
€529

Stoc limitat!





Iniintata in anul 1953 de catre fratii Ismail si Ibrahim SAHIN ca o afacere de familie, cu scopul productiei de utilaje pentru industria textilelor si ulterior pentru productia de masini de gaurit, fierastrai si ciocane pneumatice.

Incepand cu anul 1979 firma incepe operatiunile de export catre Germania. Dupa restructurarea din anul 1980, compania isi concentreaza capacitatile de productie catre utilajele pentru prelucrarea tablelor si produce primele masini de roluit tabla cu 3 role, primele masini de roluit profile si primele foarfeci combinate hidraulice, cu exporturi catre Europa si SUA.

In prezent SAHINLER se numara printre liderii producatori de astfel de masini, cu export in 85 de tari.



MASINA DE ROLUIT PROFILE HPK-120

COD: HPK-120



DOTARE STANDARD

- ① Structura din otel sudata;
 - ② 3 role actionate hidraulic.
 - ③ Role standard calite
 - ④ Panou de control mobil.
 - ⑤ Pozitie de lucru orizontal si vertical
 - ⑥ Afisaj digital de cote (2 bucati)
 - ⑦ Role de ghidare mecanice laterale pe 3 axe
 - ⑧ Reglare infinit de variabila a vitezei
- Role inferioare deplasabile hidraulic

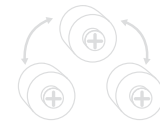

Diametrul axelor	120 mm
Diametrul roloilor	390 mm
Viteza de lucru	2-7,5 m/min
Putere motor	15 kW
Dimensiuni (LxIxh)	2000x1650x1900 mm
Greutate	4450 kg

€45774
€47932

GARANTIE 36 Luni | TRANSPORT GRATUIT | PIF GRATUIT | ACHIZITIE EXTRA COMUNITARA

MASINA DE ROLUIT PROFILE HPK-100

COD: HPK-100



DOTARE STANDARD

- ① Structura din otel sudata;
 - ② Cutia de viteze unica cu hidromotor actioneaza 3 role printr-un sistem de angrenaje
 - ③ Pozitie de lucru orizontala si verticala
 - ④ Panou de control mobil.
 - ⑤ Cilindri standard caliti
 - ⑥ Afisaj digital de cote (2 bucati)
 - ⑦ cele 3 Role de ghidare lateral au reglajul unghiului mecanic cu ajutorul mainii, pe 3 axe
- Role inferioare deplasabile hidraulic

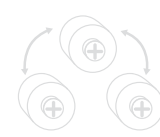

Diametrul axelor	100 mm
Diametrul roloilor	315 mm
Viteza de lucru	2-7 m/min
Putere motor	15 kW
Dimensiuni (LxIxh)	2000x1450x1700 mm
Greutate	3650 kg

€30973
€32811

GARANTIE 36 Luni | TRANSPORT GRATUIT | PIF GRATUIT | ACHIZITIE EXTRA COMUNITARA

MASINA DE ROLUIT PROFILE HPK-80 | HPK-65

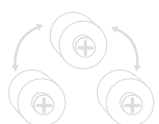

DOTARE STANDARD

- ① Constructie din otel cadru sudat
 - ② 3 role actionate hidraulic
 - ③ Arbori caliti si rectificati din material de inalta rezistenta, otel special
 - ④ Cilindrii sunt caliti si rectificati
 - ⑤ Pozitie de lucru orizontala si verticala
 - ⑥ Panou de comanda mobil
 - ⑦ Cilindri de ghidare mecanica a unghiurilor laterale pe 3 axe
 - ⑧ Motor echipat cu frana pentru indoirea de precizie
 - ⑨ Cititoare digitale (2 bucati)
- Role inferioare deplasabile hidraulic

MODEL	HPK-65	HPK-80
Diametrul axelor superioare	60 mm	80 mm
Diametrul axelor inferioare	50 mm	70 mm
Diametrul roloilor	180 mm	245 mm
Viteza de lucru	6 m/min.	7 m/min.
Putere motor	3,75 kW	4,75 kW
Lungime	1200 mm	1500 mm
Latime	850 mm	1000 mm
Inaltime	120 mm	1400 mm
Greutate	955 kg.	1645 kg.
COD	HPK-60	HPK-80
Pret lista	€15,132	€19,444
Pret promotie	€13,970	€17,850

Incepand cu
€13,970

GARANTIE 36 Luni | TRANSPORT GRATUIT | PIF GRATUIT | ACHIZITIE EXTRA COMUNITARA



No.	Tipuri de profile	HPK 65		HPK 80		HPK 100		HPK 120		
		Dimensiuni	Dimanetrul Min.	Dimensiuni	Dimanetrul Min.	Dimensiuni	Dimanetrul Min.	Dimensiuni	Dimanetrul Min.	
1		60x10 20x5	500 250	100x20* 80x20 30x10	2000 800 300	100x20 30x10	800 400	125x25 30x10	1200 500	Role standard
2		80x20 50x5	500 250	125x25 60x5	600 300	200x30 160x35 80x5	1200 800 400	200x50 100x10	1000 500	Role standard
3		32x32 12x12	400 250	45x45 15x15	500 380	60x60 15x15	750 400	65x65 20x20	750 500	Role standard
4		Ø 35 Ø 10	350 250	Ø 50 Ø 15	500 380	Ø 75 Ø 15	800 450	Ø 80 Ø 20	850 500	Role optionale
5		Ø 60x2 Ø 15x1,5	600 200	Ø 100x2,5 Ø 15x1	1200 380	Ø 125x2,5 Ø 15x1	1400 450	Ø 160x4 Ø 140x3 Ø 50x2	2800 1500 500	Role optionale
6		Ø 2" x3,91 Ø 1/2" x2,77	400 200	Ø 3" x5,48 Ø 1/2" x2,77	800 380	Ø 4" x4,5 Ø 1/2" x2,77	2500 450	Ø 5" x6,35 Ø 3/4" x2,87	1500 500	Role optionale
7		50x25x3 20x15x2	450 250	80x25x3 25x15x2	800 350	100x40x4 25x15x2	1300 450	120x40x4 30x20x3	1800 500	Role optionale
8		45x3 20x2	600 300	70x3 25x2	1300 350	80x5 25x2	1500 450	90x5 30x3	1800 500	Role optionale
9		60x60x6 30x30x4	650 350	80x80x8 30x30x3	800 400	100x100x12 40x40x4	1000 700	120x120x12 40x40x4	1200 600	Role optionale
10		50x50x5 30x30x4	550 350	70x70x7 30x30x3	700 450	100x100x10 40x40x4	1500 550	100x100x10 40x40x4	1200 600	Role optionale
11		60x7 20x3	550 250	80x9 25x3,5	800 450	100x11 30x4	1000 400	100x11 30x4	800 500	Role standard
12		50x6 20x3	500 250	70x8 25x3,5	800 280	90x10 30x4	1000 400	100x11 30x4	1000 500	Role standard
13		60x70 20x3	500 250	80x9 30x4	800 280	100x11 30x4	1000 400	100x11 30x4	800 500	Role optionale
14		UPN 80 UPN 30	600 250	UPN 140 UPN 120 UPN 100	1600 900 800	UPN 180 UPN 30	900 400	UPN 220 UPN 180 UPN 40	1000 800 500	Role standard*
15		UPN 65 UPN 30	600 250	UPN 140 UPN 120 UPN 100	1600 1000 800	UPN 180 UPN 30	1000 400	UPN 220 UPN 180 UPN 40	1200 900 600	Role standard*
16		IPN 80	600	IPN 120 IPN 80	600 400	IPN 180 IPN 80	1000 400	IPN 220 IPN 80	1000 500	Role standard*
17						HEA 120 HEB 100	1000 1200	HEA 140 HEB 120	1200 1200	Role standard*
18								UPN 120 UPN 100	10000 7500	Role optionale**
19								IPN 160 IPN 140 IPN 100	5000 4000 2000	Role optionale**
20								HEA 120 HEB 100	4000 1600	Role optionale**

* Este necesara achizitionarea saibei speciale / **Doar cu dispozitiv special de indoire

MASINA DE ROLUIT PROFILE MC200H



- cu actionare hidraulica

€9553
€10196

Set role + distantiere pentru 9 tipuri de profile

Teava patrata, rectangulara

Bara plina patrata, rectangulara si rotunda

Profile U, T, profile la unghi

Platbanda normala sau cu margini rotunjite

NARGESA®

COD: 100-08-03-001

Diametul axelor	40 mm
Lungime utila ax	74 mm
Capacitate max. teava rotunda	2 1/2 inch / 70 mm
Viteza role	8 rot/min
Putere motor	1,85 KW
Greutate	360 kg.



MASINA DE ROLUIT PROFILE MC200



€6609
€6977

Set role + distantiere pentru 9 tipuri de profile

Teava patrata, rectangulara

Bara plina patrata, rectangulara si rotunda

Profile U, T, profile la unghi

Platbanda normala sau cu margini rotunjite

NARGESA®

COD: 100-08-02-002

Diametul axelor	40 mm
Lungime utila ax	74 mm
Capacitate max. teava rotunda	2 1/2 inch / 63.5 mm
Viteza role	8 rot/min
Putere motor	1,1 KW
Greutate	320 kg.



MASINA DE ROLUIT PROFILE PMB-160H



BEST SELLER

€7802
€8400

Set role + distantiere pentru 8 tipuri de profile

Platbanda

Bara plina patrata

Profile T si U

PROMA

COD: 125400-1

Diametul axelor	50 mm
Diametul roloilor	152/162 mm
Capac. max. teava rotunda	2 inch / 70 mm
Viteza de lucru	4,5 m/min
Putere motor	1,1 kW / 400 V
Greutate	500 kg



MASINA DE ROLUIT PROFILE PMB-150M

COD: 125010-1

PROMA



BEST SELLER

€4280
€4874

Diametul axelor	50 mm
Diametul roloilor	155 mm
Cap. max. teava rotunda	2 inch / 70 mm
Viteza de lucru	4,5 m/min
Putere motor	1,5 kW / 400V
Greutate	400 kg

Livrare imediata din stoc



MASINA DE ROLUIT PROFILE PMB-120M

COD: 125000-1

PROMA



BEST SELLER

€3280
€3627

Diametul axelor	30 mm
Diametul roloilor	118/148 mm
Cap. max. teava rotunda	1 1/2" / 60 mm
Viteza de lucru	2-4 m/min
Putere motor	0,85 kW / 400V
Greutate	220 kg

Livrare imediata din stoc



MASINA HIDRAULICA DE INDOIT TEVI CU DORN CNC 32R1 ECO 3100 mm



COD: CNC32R1ECO+M1MT

Capacitate max. teava otel	32 x 2 mm
Capacitate max. teava inox	25 x 1.5 mm
Capacitate max. profil otel	30x30x1,5 mm
Lungime dorn	3100 mm
Raza min /max de indoire	20 / 225 mm
Viteza de indoire	60°/sec
Unghi maxim de indoire	190°
Putere totala instalata	6 kW/400V
Greutate	1000 kg



CANSA MAKINA
SANAYI VE TIC. LTD. ŞTİ.

€49500
~~€57491~~



Dotari si specificatii



- Control CNC
- PC cu ecran tactil 10" PC
- Simulare 3D
- 2 servo motoare
- Servo avans
- Servo rotatie
- Indoire prin motor cu cutie viteze
- Prindere teava hidraulica
- Matrita actionata hidraulic
- Dorn actionat hidraulic
- Suport actionat hidraulic Pen-sete colectoare hidraulice

- Pagina cu afisare erori masina
- Calculare lungime teava / tub
- Encoder pentru unghiul de indoire
- Sistem lubrefiere masina automat
- Activare automata sistem racire
- Mod de lucru: automat, semi-automat si manual
- Mod de lucru: fara dorn
- Afisare productie zilnica / total productie
- Pedalier cu interuptor de urgenta

- Memorare programe productie realizate
- Presiune hidraulica max. 120 bar
- Sistem de siguranta cu lumini de avertizare
- Safety plate on the front and back of the bending head
- Panou de control si cabinet electric securizat cu sistem inchidere la cheie
- 1 set de scule

MASINA HIDRAULICA DE INDOIT TEVI CU DORN + DOTARI CMH 76+MC+LM

COD: CMH76+MC+LM



DOTARE STANDARD

Menhina strangere hidraulica

Dorn actionat manual

Panou de comanda

Motor reductor

Sistem de franare cu pedalier

Set de scule de indoire

Dotari incluse:

+ Carucior prindere manuala univesal (MC)

+ Lubrifiere automata a dornului (LM)

€39836
~~€42989~~

Stoc limitat!

Capacitate max. teava otel	76 x 4 mm
Lungime dorn	3150 mm
Raza max de indoire	250 mm
Viteza de indoire	48°/sec
Unghi maxim de indoire	190°
Putere totala instalata	13 kW/400V
Greutate	1500 kg



CANSA MAKINA
SANAYI VE TIC. LTD. ŞTİ.

MASINA ELECTRICA DE INDOIT TEVI CU DORN CM-32S

COD: 52624S



DOTARE STANDARD

Dispozitiv strangere cu excentric

Raportor gradat indoire

Motor electric

Panou comanda cu pedalier

Suport cu role

Cabinet electric cu cheie

Capacitate max. teava otel	32 x 2 mm
Lungime dorn	1650 mm
Viteza de indoire	72°/sec
Unghi maxim de indoire	190°
Putere totala instalata	2,2 kW 400V
Greutate	220 kg
Greutate	1500 kg

€6985
~~€7314~~



CANSA MAKINA
SANAYI VE TIC. LTD. ŞTİ.

MASINA ELECTRICA DE INDOIT TEVI FARA DORN CC90CNC



€19900
€23267

DOTARE STANDARD

Control CNC cu ecran tactil de 7"

Pana la 10.000 de programe

Indoire stanga / dreapta

Pedaliere pornire/ oprire de siguranta

50 unghiuri pe aceeaasi piesa

Matrite din otel calit

N NARGESA®

COD: 100-17-02-001

Capacitate max. teava otel	90 x 6 mm
Capacitate max. teava inox	88,9 x 4mm
Capacitate max. profil otel	60 x 60 x 4mm
Viteza de indoire	2,2 rpm
Unghi maxim de indoire	180°
Putere totala instalata	2,2 KW / 400V
Greutate	860 kg



MASINA ELECTRICA DE INDOIT TEVI FARA DORN CC60CNC



€11900
€12483

DOTARE STANDARD

Control CNC cu ecran tactil de 7"

Pedaliere pornire/ oprire de siguranta

Maxim 10.000 de programe

50 unghiuri pe aceeaasi piesa

Indoire stanga / dreapta

Matrite din otel calit

N NARGESA®

COD: 100-17-01-001

Capacitate max. teava otel	60 x 4 mm
Capacitate max. teava inox	60 x 3 mm
Capacitate max. profil otel	40 x 40 x 4mm
Viteza de indoire	3,5 rpm
Unghi maxim de indoire	180°
Putere totala instalata	1,1 KW / 400V
Greutate	365 kg



MASINA HIDRAULICA DE INDOIT TEVI FARA DORN BK-H060

COD: BK-H060



Capac. indoire min / max	Ø6 / 60 mm
Raza max.	200 mm
Unghi max. de indoire	210°
Viteza de indoire	6 rot/min.
Greutate aprox.	141 kg

Stoc limitat!

€7984
€10257



MASINA ELECTRICA DE INDOIT TEVI FARA DORN UNI 60A DIGITAL

COD: 9200345.5



Diametrul max. teava	54 mm
Grosime max. perete	2 mm
Unghi max. indoire	180°
Putere motor	0,96 kW/230V
Greutate	60 kg

€6870
€7231



MASINA ELECTRICA DE INDOIT TEVI FARA DORN UNI 63 3 FAZE

COD: 9200563



Diametrul max. teava	54 mm
Grosime max. perete	2 mm
Unghi max. indoire	180°
Putere motor	1,1 kW/400V
Greutate	120 kg

Stoc limitat!

€5378
€9541



MASINA ELECTRICA DE INDOIT TEVI FARA DORN UNI 42A DIGITAL

COD: 9200121.5



Diametrul max. teava	42 mm
Grosime max. perete	1,5 mm
Unghi max. indoire	180°
Putere motor	1,02 kW/230V
Greutate	35 kg

€4972
€5234



DISPOZITIV HIDRAULIC DE INDOIT TEVI 0893



COD: 0893



€449
€505

FERVI

Presiune maxima	10 tone
Gama de diametre	1/2" - 3/4" - 1" - 1 1/4" - 1 1/2" - 2"
Cursa maxima	250 mm
Greutate	48 kg

Livrare imediata din stoc



DISPOZITIV DE INDOIT IN FORMA DE S 0113

COD: 0113



BEST SELLER

€256
€291

- Pentru indoire la rece
- Limitator material
- Maner ergonomic

FERVI

Plat banda	10x30 mm
Rotund	10 mm
Patrat	10 x 10 mm
Matrite	80 mm 125 mm 200 mm
Greutate	25 kg



DISPOZITIV DE INDOIT UNIVERSAL 0197

COD: 0197

FERVI



€404
€455

Profil rotund	Otel, Cupru 16 mm Fier forjat 12 mm aluminiu de 18 mm
Platbanda	30 x 8 mm
Profil patrat	Otel, Cupru 13 x 13 mm Fier forjat 10 x 10 mm Aluminiu 15 x 15 mm
Greutate	22 kg



DISPOZITIV DE INDOIT UNIVERSAL 0102

COD: 0102

FERVI



€254
€289

Profil rotund	Rece 22 mm cald 27 mm
Platbanda	Otel 100 x 8 mm Cupru 100 x 15 mm
Profil patrat	Rece 20 mm cald 25 mm
Greutate	30 kg

Livrare imediata din stoc



DISPOZITIV DE INDOIT TEVI ROT-180K

COD: 25373215

PROMA



€312
€369

Indoire teava	3/8", 1/2", 9/16", 5/8", 3/4", 7/8"
Indoire patrat	3/4", 1"
Grosime teava	0,8 - 1,2 mm
Unghi max. indoire	180°
Greutate	25 kg



DISPOZITIV DE INDOIT UNIVERSAL U0-120

COD: 25100101

PROMA



€313
€370

Platbanda (otel)	100 x 5 mm
Profil rotund	18 mm
Profil rectangular	16 x 16 mm
Cornier	60 x 8 mm
Unghi indoire:	0 - 100°



MASINA DE SANFRENAT SI DEBITAT TEVI PNEUMATICA MCA CUTTER MCA3

COD: MCA3



Aria de lucru O.D	67-220 mm
Cursa inel portcutit	50 mm
Consum aer	1800 l/min
Presiune aer	6 bar
Viteza de lucru	30 rpm
Putere motor	1.3 kW/ 220 V
Greutate	26 kg

Operatiuni posibile **debitare, sanfrenare, acoperire, zencuire**
Materiale care pot fi prelucrate **otel carbon, aliaje, otel inoxidabil, duplex**

G.B.C.
Industrial Tools s.p.a

Stoc limitat!

€12849
€16591



DISPOZITIV POZITIONARE CONDUCTE FLANSE TEVI SPIDER 400-940 MM



Stoc limitat!

G.B.C.
Industrial Tools s.p.a

Date tehnice	SPIDER 940	SPIDER 520	SPIDER	SPIDER	SPIDER
Domeniul de prindere	400-940 mm	180-520 mm	120-350 mm	85-220 mm	54-140 mm
Greutate	39 kg	27 kg	10.5 kg	3.6 kg	1.25 kg
COD	FTP940	FTP520	FTP350	FTP220	FTP140
Pret lista	€1674	€1211	€629	€438	€327
Pret promotie	€1355	€980	€509	€354	€265

Incepad cu
€265



DISPOZITIV DE PRINDERE CU LEVIER CONDUCTE MARI SINGLE CHAIN CLAMPS

COD: SCC36

G.B.C.
Industrial Tools s.p.a



Diametru max. teava	10-36"
Greutate	42 kg

Stoc limitat!

€866
€1719



MASINA DE SLEFUIT CU BANDA BPS-151/400

COD: 25702155

PROMA



Dimensiuni banda	2260x150 mm
Viteza banda	960 m/s
Dimensiune masa	820x170 mm
Unghi inclinare	0 - 90°
Putere motor	2,2 kW/400 V

€890
€1029



MASINA DE SLEFUIT CU BANDA PASOVEC 150

COD: 3150/2/3

NED
MACHINES



Dimensiune banda	150 x 2000 mm
Numar viteze	(2)1800/900 m/min
Putere motor	4 kW / 400 V
Greutate	89 kg

€986
€1033



MASINA DE SLEFUIT CU BANDA PASOVEC 75

COD: 3075/2/3

NED
MACHINES



Dimensiune banda	75 x 2000 mm
Numar viteze	(2)1800/900 m/min
Putere motor	3 kW / 400 V
Greutate	67 kg

€799
€837



MASINA DE SATINAT/SLEFUIT TEVI LPC-160

COD: LPC160



Diametru min./max	5-50 mm
Raza min. curbare	80 mm
Dimensiuni banda	30 x 622 mm
Putere motor	1,1 + 2,2 kW/400V
Greutate neta	185 kg.

€8800
€9742



MASINA DE SLEFUIT CU BANDA BPK-2075/400

COD: 25702154



Dimensiune banda	2000 x 75 mm
Viteza banda:	30 m/s
Putere motor	3 kW/400V
Greutate	66 kg

€727
€835

Stoc limitat!



MASINA DE SLEFUIT CU BANDA BPK-2100/230

COD: 25702156



Dimensiune banda	1220x100 mm
Viteza banda:	19 m/s
Putere motor	1,5 kW/230V
Greutate	35,5 kg

€445
€512

Stoc limitat!



MASINA DE SLEFUIT METAL CU DISC BKC-305

COD: 25350305



Diametru disc	305 mm
Turatie	1400 rpm
Unghi inclinare	0-45°
Putere motor	0,55 kW/230V
Greutate	32 kg

€298
€379



MASINA DE SLEFUIT CU BANDA SI DISC 0662

COD: 0662



Dimensiuni banda	1219 x 152 mm
Dimensiuni disc	230 mm
Viteza banda / disc	330 m/min / 1400 m/min
Putere motor	0.75 kW/230V
Greutate	54 kg

€584
€675



MASINA DE SLEFUIT CU BANDA SI DISC BP-150

COD: 25702150



Dimensiune banda	150x1220 mm
Diametru disc	230 mm
Viteza banda / disc	330 m/min / 1400 rpm
Putere motor	0.55 kW/230V
Greutate	55 kg

€384
€448

Livrare imediata din stoc



MASINA DE SLEFUIT CU BANDA SI DISC 0523

COD: 0523



Dimensiuni	530 x 430 x 330 mm
Dimensiuni banda	100 x 914 mm
Diametru disc	ø 150 mm
Putere motor	0.375 kW / 230V
Turatii	1850 rpm
Greutate	20 kg

€388
€441



MASINA DE SLEFUIT CU BANDA SI DISC 0505

COD: 0505



Dimensiuni banda	100 x 914 mm
Dimensiuni disc	150 mm
Turatii	2850 rot/min
Putere motor	0.5 kW / 230V
Greutate	18 kg

€238
€270



Super Xtrafactory Devices

Afacere inceputa in anul 1960 de catre dl. Evangelista Russo, care a inventat si dezvoltat diverse sisteme de tractare si angrenare cu lant pentru industrie si agricultura. In anul 1997 dl. Russo infiinteaza compania Elsa S.r.l, si produce primul model SUPERCOMBINATA. In acelasi an castiga premiul inventatorilor de la Geneva si isi incepe turul lumii pentru a promova linia sa de produse.

Compania continua sa dezvolte modele noi in urmatoorii ani si incepand cu anul 2004 firma devine recunoscuta la nivel mondial, pentru produsele sale de calitate si cu performante deosebite.

Printre calitatile firmei si produselor Elsa se numara: cea mai solida masina portabila din lume; inovatie, lider de piata, calitate fara comparatie, reputatie internationala, inclinatie pentru satisfactia clientului.

Masinele ELSA sunt compatibile cu orice sursa de tip MIG/MAG



Incepand cu
€10,804

MASINA PORTABILA PENTRU ALEZAT SI SUDAT 62-800 MM | 42-400 MM | 2-100 MM
SUPERCOMBINATA SC3 60/2 | SUPERCOMBINATA SC1 40/1 | SUPERCOMBINATA EASY



Date tehnice	SUPERCOMBINATA SC3 60/2	SUPERCOMBINATA SC1 40/1	SUPERCOMBINATA EASY
	STRUNJIRE		
	ALEZARE		
	FREZARE		
	FILETARE		
	FREZARE FLANSA		
	SECTIONARE LONGITUDINALA		
Bara de alezat	Ø 60 x 2200 mm mm	Ø 40 x 2200 mm	Ø 40 x 2200 mm
Diametru alezare	Ø 62 ÷ Ø 800 mm	Ø 42 ÷ Ø 400 mm	Ø 22 ÷ Ø 250 mm
Turatia in gol	2800 rpm	2800 rpm	2800 rpm
Putere utila	2.3 kW/230 V	1,8 kW//230 V	1,8 kW//230 V
Greutate	39 kg	36 kg	36 kg
COD	SC360/2	SC140/1-P	SCEasy
Pret lista	€22,985	€17,604	€14,421
Pret promotie	€ 19,553	€ 15,043	€ 10,804

Stoc limitat!

DOTARI:

- Unitatea de lucru
- Panou de control electronic
- Bara alezat
- Extensie bara alezat
- Lance pentru sudare exterioara (doar la SC360/2)
- Torta telescopica
- Extensie
- Duze
- Cap contact lung/scurt

- Pana reglare portsucle
- Cutit cu 10 muchii taietoare
- Portscula dreapta
- Portscula stanga
- Portscula alezat
- Portscula frezat (doar la SC360/2)
- Suporti bara
- Suporti aditionali
- Kit de centrare (doar la SC360/2)
- Kit prindere ax principal

- Ceas comparator
- Suport ceas comparator
- Comparator telescopic (doar la SC360/2)
- Micrometru de interior
- Suporti prindere flansa (doar la SC360/2)
- Suporti flansa (doar la SC360/2)
- Cablu Panou de control
- Cablu de alimentare 220 V
- Suport-Postament masina
- Kit scule de montaj



N NARGESA®

50 years
manufacturing industrial machinery

Prada NARGESA S.L., fondata in 1970, cu sediul in Barcelona, Spania, este specializata in productia de utilaje industriale de prelucrare metal. Pana in prezent firma numara peste 6000 de clienti si mai mult de 12000 de utilaje vandute in toata lumea. Toate componentele electrice si hidraulice sunt provenite de la producatori de renume din Europa. Toate masinile sunt atent urmarite din punct de vedere al calitatii in procesul de productie si testate inainte de livrare.



CUPTOR DE FORJA



CIOCANE DE FORJA



MASINI DE TORSIONAT



MASINI DE AMPRENTAT



FOARFECI COMBIMATE



MASINI DE BROSAT



MASINI DE INDOIT



PRESE ORIZONTALE



MASINA DE TORSIONAT FIER FORJAT LA RECE AUTOMATA MT500A | MT150A



COD: 100-01-03-001

€15,750
~~€17,566~~



BEST SELLER

€7,900
~~€8,517~~

COD: 100-01-02-001



Date tehnice	MT500A	MT150A
Capacitate max. torsionare	40 mm (1 3/8")	20 mm (3/4")
Capacitate max. indoire:	25 mm (1")	16 mm (5/8")
Capacitate max. platbanda, carlige	50x10 mm (2"x 3/8")	35x10 mm (1 1/4"x3/8")
Lungime max torsionare:	1.620 mm.	960 mm.
Putere motor:	4 kW	0,37 kW
Tensiune:	230/400 V	230 V
Turatie	0 - 10 r.p.m.	0 - 9 r.p.m.
Dimensiuni:	2220x 980x1280 mm	2260x 630x1120 mm
Greutate:	1350 kg.	260 kg.
Panou de control		
	Usor de utilizat Ecran digital Taste tip tactil Numarator piese Derulator automat Memorie 8 programe de torsionare Panou de control independent	Operare intuitiva Ecran digital Taste tip tactil Numarator piese Derulator automat Memorie 8 programe de torsionare

MASINA DE AMPRENTAT LA CALD VARFURI SI CAPETE NF70

COD: 100-12-02-001

N NARGESA®



Semifabricat rotund	Ø 20 mm
Semifabricat patrat	20 mm
Semifabricat platbanda	40x10 mm
Putere motor	5,5 kW/400 V
Greutatea	450 kg.

€9950
€12037



MASINA DE AMPRENTAT LA CALD VARFURI SI CAPETE PC16

COD: 100-15-01-001

N NARGESA®



Semifabricat rotund	Ø 20 mm
Semifabricat patrat	20 mm
Semifabricat platbanda	50x10 mm
Putere motor	2,2 kW/400 V
Greutatea	310 kg.

€6700
€7484



CUPTOR DE FORJA PE GAZ PROPAN H3

COD: 100-04-04-001

N NARGESA®



Dimensiuni interioare	464 x 240 x 100 mm
Temperatura	1300°C
Numar de arzatoare	3
Consum maxim	1 kg/ora / 1 bar
Presiune de lucru	0.1 - 1.5 bar
Greutate	53 kg

€2447
€2553



CUPTOR DE FORJA PE GAZ PROPAN H2

COD: 100-04-01-001

N NARGESA®



Dimensiuni interioare	324x240x100 mm
Temperatura	1300°C
Numar de arzatoare	2
Consum maxim	0,7 kg/ora / 1 bar
Presiune de lucru	0.1 - 1.5 bar
Greutate	40 kg

€1698
€1772



CUPTOR DE FORJA PE GAZ PROPAN H1

COD: 100-04-03-001

N NARGESA®



Dimensiuni interioare	140x236x100 mm
Temperatura	1300°C
Numar de arzatoare	1
Consum maxim	0,35 kg/ora / 1 bar
Presiune de lucru	0.1 - 1.5 bar
Greutate	35 kg

€1233
€1286



CUPTOR DE FORJA PE GAZ PROPAN 0668

COD: 0668

BEST SELLER

FERVI



Dimensiuni interioare	280x210x100 mm
Capacitati lucru	Ø 70 mm / ■ 50 mm
Temperatura	1300-1400°C
Numar de arzatoare	G.P.L.
Consum maxim	0,05-1,5 kg/ora
Greutate	25 kg

€1190
€1373



Livrare imediata din stoc



CIOCAN PNEUMATIC DE FORJA PH-6000



PROMA

COD: 127060-1

DOTARE STANDARD

Control la pedala	Pozitii lucru interschimbabile pentru capetele ciocanului si a nicovalei
Sistem lubrifiere pneumatic	Control la pedala
Microintrerupator urgenta	Ecran protectie plastic zona lucru piston

Forța nominală	60 kg
Cursă maximă	220 mm
Numar lovituri	220 /min
Putere motor	7.5 kw
Turatii motor	1400 rot/min
Greutate	1300 kg

€12800
€14355



CABINA DE SABLAT cu VAS PRESIUNE PAL4-XL+PAL-5SP



€6775
€7082

- ✓ sablare corpuri decorative
- ✓ sablare metale calite
- ✓ debavurare
- ✓ tratarea suprafetelor si curatarea

Dimensiuni lucru	1440 x 1090 x 800 mm
Debit aer	3 lt./600 min -3.5 lt./ 800 min -4 lt./1200 min
Aspirator	0.75 kW
Iluminare cabina	20 W
Presiunea de lucru	1,5 - 8 bar
Duza Tungsten	Ø 6-8-10 (una la alegere)
Bazin sub presiune	60 lt



CB

COD: PAL4-XL+PAL-5SP

CABINA DE SABLAT PAL 2/N

COD: PAL2-N

CB



€2987
€4436

Dimensiuni de lucru	880 x 600 x 780h mm
Debit aer	3,0 lt / 600 min
	3,5 lt / 800 min
	4,0 lt / 1200 min
Presiunea de lucru	1,5 - 8 bar

Stoc limitat!



CABINA DE SABLAT 0615

COD: 0615

FERVI



€3322
€3621

Dimensiuni de lucru	1180 x 850 x 890h mm
Presiune de lucru	6 ÷ 8 bari
Consum aer	880 l / min
Duze	6 - 7 mm
Rata de filtrare	8 microni
Putere motor	0,7 kW/230V



CABINA DE SABLAT cu 2 ASPIRATOARE 0605

FERVI

COD: 0605



BEST SELLER

DOTARE STANDARD

- 2 saci colectori tip ciclon
- filtru de hartie
- rezervor sub presiune
- deschidere frontala
- plafan cu 3 lampi fluorescente

€2680
€3144

Dimensiuni de lucru	1180 x 850 x 890 h mm
Presiune de lucru	6 ÷ 8 bari
Consum aer	880 l / min
Duze	6 - 7 mm
Rata de filtrare	5 microni
Putere motor	1,2 kW/230V



CABINA DE SABLAT 0575S

COD: 0575S

FERVI



€593
€668

Dimensiuni de lucru	860 x 560 x 560h mm
Presiune lucru	6,5 - 7,5 bar
Consum aer	240-300 l/min
Duze	4 - 5 - 6 - 7 mm
Greutate	46,5 kg
Putere motor	1,2 kW/230V



CABINA DE SABLAT MINI 0490 0490

COD: 0490

FERVI



€230
€418

BEST DEAL

Dimensiuni de lucru	410 x 310 x 200 mm
Presiune lucru	4 - 7,5 bar
Duze	ø 3.5 mm
Cu iluminare	230 V 6 w, 12 V
Greutate	12 kg
Putere motor	1,2 kW/230V

Stoc limitat!



MASINA DE SABLAT CB 215 D-1

COD: CB215D-1



Presiune maxi. lucru	12 bar
Capacitate abraziv	215 l
Inaltime	1400 mm
Diametru	1050 mm
Greutate	120 kg

Inclus: cutie nisip, tub abraziv d.25x40 de 10 m cu racorduri, duza, sita, furtun netoxic d.8x17 de 10 m cu racorduri, kit de aerisire, casca aerisita M06

€2881
€3011



MASINA DE SABLAT CB 60 S-1

COD: CB60S-1



Presiune maxi. lucru	12 bar
Capacitate abraziv	60 lt
Inaltime	1130 mm
Diametru	600 mm
Greutate	72 kg

Inclus: tanc nisip, tub articulata 16.0x30.0 mm L = 10 m, duza, sita, furtun atoxic 8.0x17.0 mm L= 10 m, kit ventilare, masca protectie - M02

€2180
€2224



MASINA DE SABLAT SAR LT 24

COD: SARLT24



Capacitate	24 lt
Presiune max.	8 bar
Putere motor	1.45 kW / 230 V
Inaltime	1500 mm
Greutate	70 kg

€2969
€3104



MASINA DE SABLAT CB 24 V4

COD: CB24-V4



Presiune max. lucru	8 bar
Capacitate	24 lt
Inaltime	800 mm
Diametru	500 mm
Greutate	32 kg

Inclus: cutie de nisip, tub abraziv d.16x30 de 10 m cu racorduri, duza, sita, furtun netoxic d.8x17 de 10 m cu racorduri, kit de aerisire, casca aerisita M05

€1268
€1325



INSTALATIE DE SABLAT CU CONVEIOR TZNP 2 - 7,5 / 0,8X0,5



DOTARI SI CARACTERISTICI

Transportor cu role sau cu curea	Sablare uniforma
Senzori detectare piese de sablat	Captuseala schimbator si turbine rezistente la uzura
Separarea automata material abraziv	Aspirare + filtrare automata
PLC cu ecran tactil color	

COD: TZNP2-7-5/0-8x0-5



Latimea maxima a piesei	800mm
Inaltimea maxima a piesei	500mm
Numar turbine	2
Capacitate filtru	4000 m3/h
Putere totala (inclusiv filtru):	15/24 kW/400V

€123702
€132538



MASINA DE SABLAT CU CARLIG ROTATIV TZ 2 - 5,5 / 12 - 17



DOTARI SI CARACTERISTICI

Se executa o separare a materialului abraziv	Deplasare carlige prin lant motorizat
Dispozitiv aspirare si filtrare	Turbine rezistente la uzura din fonta - mangan)
Captuseala protectie rezistenta la uzura	Sina In forma de Y cu doua carlige
PLC cu ecran tactil color	

COD: TZ2-5-5/12-17



Diametru x inaltime cabina	1200 x 1700 mm
Capacitate incarcare carlig	500 (1000) kg
Numar turbine	2
Capacitate filtru	4000 m3/h
Putere totala (inclusiv filtru):	18/22 kW

€123702
€132538



Încă de la înființarea noastră din 1919 am fost pionieri în producția de mașini proiectate pentru prelucrarea cornierelor, a platbandelor și a profilelor, deservind diverse industrii, cum ar fi feronerie, atelierele metalice, confecții metalice, telecomunicații și centre siderurgice.

De-a lungul călătoriei noastre, ne-am adaptat utilajele la nevoile în schimbare ale pieței, evoluând de la foarfeci manuale la linii automate și tehnologie CNC pentru debitare, perforare și marcare.



FOARFECI COMBIMATE



MICROCROP



BENDICROP



PUMA



HYDRACROP

LINIE CNC GAURIT PLATBANDA



ALFA 500/220T

LINIE AUTOMATA GRINZI



SIGMA 110

LINIE CNC GAURIT TABLA



PAXY

CENTRU VERTICAL GAURIRE SI FREZARE



BOHRMAX

LINIE AUTOMATA CNC CORNIERE



GAMMA TRACTION

-  **Robustness**
-  **Durability**
-  **Precision**
-  **Customization**
-  **Strength**
-  **Innovation**
-  **Quality**
-  **Safety**



www.proma.ro



Made in Spain

www.geka-group.com

LINIE AUTOMATA DE GAURIRE PENTRU PROFILE CU FOARFECA COMBINATA CU DOUA STATII DE LUCRU HYDRACROP-110 S + PAX 3000 MM | HYDRACROP-80 S + ALRS 600 7000 X 600 MM | HYDRACROP-80 S + PAX 6000 MM

Linia de produse PAX permite **pozitionarea automata a materialului** pe lungul axei X, permitand **stantarea multipla secventiala a profilelor**.

DOTARI STANDARD

Unitate transportoare si ghidaje de pozitionare

Sistem strangere material

Pozitionare servomotor

Blat de masa cu role liniare

Set reglabil manual pentru ghidaje transversale cu role

Monitor cu ecran tactil

Sina In forma de Y cu doua carlige



Inceand cu
€51465

COD: H110S000000+PAX3000 | H080S000000+PAX6000



Linia de produse ALRS este un **alimentator automat** pentru **platbanda**. Prin eliminarea manipularii greoaie a materialului, **ALRS-ul va economiseste timp** si va **creste substantial productivitatea**. Interfata ALRS-ului **accepta procesarea simultana a mai multor lungimi de lucru** si a **configuratiilor lor**.



€43919
€46359

COD: 080S000000+ALRS600

Date tehnice ALRS

Latime maxima plat banda	750 mm
Lungime maxima plat banda	7000 mm
Viteza de avans	18 m/min
Putere totala (inclusiv filtru):	15/24 kW/400V

Date tehnice	HYDRACROP-110 S + PAX 3000 MM	HYDRACROP-80 S + PAX 6000 MM	HYDRACROP-80 S+ALRS 600 7000 X 600 MM
Forta presare	1100 kN	800 kN	800 kN
Retezare profile L la 90° fara deformare	152x152x13 mm	130x130 x13 mm	130x130 x13 mm
Retezare profile L la 45°	70x70x7 mm	70x70x7 mm	70x70x7 mm
Retezare platbanda cu deformatii usoare	600x15 mm	450x15 mm	450x15 mm
Profile UPN	160 mm	140 mm	140 mm
Profile IPN	160 mm	140 mm	140 mm
Gaurire cu poanson	ø 40x20 mm	ø 40x14 mm	ø 40x14 mm
Crestare/decupare grosime	13 mm	12 mm	12 mm
Putere motor	9 kW/400V	9 kW/400V	9 kW/400V
Greutate	3162 kg	2070 kg	2070 kg
COD	H110S000000+PAX3000	H080S000000+PAX6000	H080S000000+ALRS600
Pret lista	€54,324	€58,938	€46,359
Pret promotie	€51,465	€55,836	€43,919

MASINA COMBINATA CNC PE 2 AXE DE GAURIT CU POANSON HYDRACROP-110 S + B&R 15" 1000 x 500 mm | HYDRACROP-55 S + B&R 15" 2000 x 400 mm | HYDRACROP-55 S + B&R 15" 1000 x 400 mm



Semi-Paxy este o solutie de control CNC semiautomat pentru pozitionarea materialului in foarfeca combinata.

Masa este cu control pe axele X si Y cu limitatori programabili.

Unitatea este formata dintr-un controller PC de tip industrial montat intr-o consola mobila. **GEKA B&R 15"** Incorporeaza un monitor cu ecran tactil de 15,6" cu o interfata intuitiva si extrem de usor de utilizat, dezvoltata de Geka pentru o navigare usoara in toate etapele de functionare.

Incepand cu
€37215



Date tehnice	HYDRACROP-110 S + B&R 15" 1000 x 500 mm	HYDRACROP-55 S + B&R 15" 2000 x 400 mm	HYDRACROP-55 S + B&R 15" 1000 x 400 mm
Forta presare	1100 kN	550 kN	550 kN
Retezare profile L la 90° fara deformare	152x152x13 mm	120x120x10 mm	120x120x10 mm
Retezare profile L la 45°	70x70x7 mm	70x70x7 mm	70x70x7 mm
Retezare platbanda cu deformatii usoare	600x15 mm	300x15 mm	300x15 mm
Profile UPN	160 mm	120 mm	120 mm
Profile IPN	160 mm	120 mm	120 mm
Gaurire cu poanson	ø 40x20 mm	ø 40x10 mm	ø 40x10 mm
Crestare/decupare grosime	13 mm	10 mm	10 mm
Putere motor	9 kW/400V	5 kW/400V	5 kW/400V
Greutate	3162 kg	1390 kg	1390 kg
COD	H110S0000000+BR151000500	H055S0000000+BR152000400	H055S0000000+BR151000400
Pret lista	€ 51073	€ 45006	€ 39282
Pret promotie	€ 48385	€ 42638	€ 37215

FOARFECA COMBINATA CU DOUA STATII DE LUCRU HYDRACROP-80 S | HYDRACROP-55 SD



Incepand cu
€15850

Date tehnice	HYDRACROP-80 S	HYDRACROP-55 SD
Forta presare	800 kN	550 kN
Retezare profile L la 90° fara deformare	130x130 x13 mm	120 x 120 x 10 mm
Retezare profile L la 45°	70x70x7 mm	70x70x7 mm
Retezare platbanda cu deformatii usoare	450x15 mm	200x20 mm
Profile UPN	140 mm	120 mm
Profile IPN	140 mm	120 mm
Gaurire cu poanson	ø 40x14 mm	ø 40x10 mm
Crestare/decupare grosime	12 mm	10 mm
Putere motor	9 kW/400V	5 kW/400V
Greutate	2070 kg	1750 kg
COD	H080S0000000	H055X0000000
Pret lista	€ 20314	€ 17734
Pret promotie	€ 18800	€ 15850



FOARFECA COMBINATA CU DOUA STATII DE LUCRU BENDICROP 60 S



Linia de produse PAX permite pozitionarea automata a materialului pe lungul axei X, permitand stantarea multipla secventiala a profilelor.

€17900
€20314

COD: B060S0000000



STATII LUCRU
Stantare
Crestare
Foarfece platbanda
Taiere bare rotunde / patrate
Indoire

Forta presare	600 kN
Retezare platbanda	350 x 15 mm
Retezare profile L 90°	120 x 120 x 10 mm
Bara rotunda	ø 45 mm
Bara patrata	40 mm
Crestare/decupare	10 mm
Gaurire cu poanson	ø 40x11 mm
Putere motor	5,5 kW/400V
Greutate	1390 kg



FOARFECA COMBINATA CU DOUA STATII DE LUCRU BENDICROP-50



€12950
€14175

COD: B0500000000



STATII LUCRU
Stantare
Crestare
Foarfece platbanda
Taiere bare rotunde / patrate
Indoire

Forta presare	500 kN
Retezare platbanda	350 x 10 mm
Retezare profile L 90°	80 x 80 x 8 mm
Bara rotunda	ø 35 mm
Bara patrata	30 mm
Crestare/decupare	10 mm
Gaurire cu poanson	ø 31 x 12 mm / ø 27 x 13 mm
Putere motor	3 kW/400V
Greutate	1200 kg



FOARFECA COMBINATA CU O STATIE DE LUCRU MULTICROP-45



€12780
€14004

COD: U0450000000



STATII LUCRU
Stantare
Crestare
Foarfece platbanda
Taiere bare rotunde / patrate
Indoire

Forta presare	500 kN
Retezare platbanda	350 x 10 mm
Retezare profile L 90°	80 x 80 x 8 mm
Bara rotunda	ø 35 mm
Bara patrata	30 mm
Crestare/decupare	10 mm
Gaurire cu poanson	ø 31 x 12 mm / ø 27 x 13 mm
Putere motor	3 kW/400V
Greutate	1200 kg



FOARFECA COMBINATA CU O STATIE DE LUCRU MINICROP-45

COD: I04500000000



STATII LUCRU
Stantare
Crestare
Foarfece platbanda, profile tip I
Taiere bare rotunde / patrate

Forta presare	450 kN
Retezare platbanda	300 x 10 mm
Retezare profile L 90°	80 x 80 x 8 mm
Bara rotunda	ø 30 mm
Bara patrata	30 mm
Crestare/decupare	7 mm
Gaurire cu poanson	ø 27 x 13 mm
Putere motor	2,2 kW/400V
Greutate	800 kg

€10800
€11697



FOARFECA COMBINATA CU O STATIE DE LUCRU MICROCROP-36

COD: M03600000000



Forta presare	360 kN
Retezare platbanda	350 x 6 mm
Retezare profile L 90°	80 x 80 x 8 mm
Gaurire cu poanson	ø 27 x 10 mm
Putere motor	2,2 kW/400V
Greutate	575 kg

€7950
€8577



FOARFECA COMBINATA PENTRU METAL MX700 | MX340G



€15831
€16896

COD: 100-02-02-003



COD: 100-02-01-002



€7798
€8232

Presă hidraulică multifuncțională pentru perforat, debitat și îndoit MX700, are dezvoltată o gamă mare de scule opționale: poansonane, matrice și dispozitive răspunzând astfel unui spectru larg de aplicații.

Presă hidraulică de stantat tablă și profile MX340G se caracterizează prin versatilitatea sa. MX340G poate efectua mai multe funcții de lucru, cum ar fi:

- debitare, îndoire, ștanțare (fasonare), gaurire (rotund-oval-patrat), ambutisare, în tablă, platbandă, profil U, T, UPN, IPN, teavă



Date tehnice	MX700	MX340G
Putere hidraulică	700 kN	400 kN
Viteza de lucru	9 mm/sec	7,1 mm/s
Viteza de revenire	14 mm/sec	9,3 mm/s
Cursa poanson	160 mm	100 mm
Adancime gat	350 mm	180 mm
Dimensiuni masa	600x350 mm	245 x 265 mm
Putere motor	5,5 kW/400V	2,2 kW/400V
Greutate	2000 kg	615 kg
COD	100-02-02-003	100-02-01-002
Pret lista	€16,896	€8,232
Pret promotie	€15,831	€7,798



FOARFECA COMBINATA PENTRU METAL HEP-850 | HEP-602



Stoc limitat!

€19793
~~€23411~~

COD: 127010-1



DOTARE HEP-850

Poanson si matrita 22 mm	Instalatie de iluminat
Suport poanson	Instalatie de ungere
Cutit pentru debitat platbanda	Limitatori actionati electric
Cutit pentru debitat profil patrat si rotund	Cheie tip C
Foarfeca de taiat in unghi	Manual de utilizare



PROMA

Livrare imediata din stoc

€8950
~~€11835~~

COD: 126990-1



DOTARE HEP-602

Suport poanson	Foarfeca de taiat in unghi
Cutit pentru debitat tabla	Instalatie de ungere
Cutit debitare profil patrat si rotund	Limitatori actionati electric
Cheie tip C	Manual de utilizare
Poanson si matrita 22 mm	

Forța presare	850 kN	600 kN
Debitare tabla	380x20-480x15 mm	200x20-300x15 mm
Debitare bare otel	50 mm	40 mm
Debitare cornier 90°	150x150x15 mm	120x120x12 mm
Gaurire cu poanson	Ø 110 x 4 mm	Ø 38 x 11 mm
Crestare/decupare grosime	13 mm	10 mm
Putere motor	7,5 kW/400V	4 kW/400V
Greutate	2315 kg	1440 kg
COD	127010-1	126990-1
Pret lista	€23,411	€11,835
Pret promotie	€ 19,793	€ 8,950

FOARFECA MANUALA PENTRU DEBITAT METAL SI TABLA HS-10 | 0773/10 | 0773/05

PROMA

FERVI



Inceand cu
€120

BEST DEAL

Date tehnice	HS-10	0773/10	0773/05
plat banda	70x5 mm	70x3 mm	38x3 mm
tabla metal	5 mm	0,5-3 mm	0,5-3 mm
profil circular	13 mm	6 mm	6 mm
Lungime cutit	250 mm	250 mm	130 mm
Greutate	23 kg	23 kg	10 kg
COD	25372104	0773/10	0773/05
Pret lista	€244	€228	€137
Pret promotie	€ 199	€ 201	€ 120



Livrare imediata din stoc

Livrare imediata din stoc



DENER®

G R O U P

DENER MAKİNA, infiintata in anul **1974**, in **Kayseri, Turcia**, are ca obiect de activitate fabricarea de utilaje prelucrare tabla, precum: Masini cu laser pentru debitat tabla, Abkant-uri servo hidraulice, Abkant-uri hidraulice, Abkant-uri hibride, Ghilotine hidraulice cu NC sau CNC, Masini de debitat cu plasma.

Filozofia de productie Dener este reprezentata de urmatoarele deziderate: **calitate maxima** si **grad ridicat de tehnologie**. Dener Makina este lider de piata intre producatorii turci de utilaje prelucrare tabla.

In anul **2008** DENER stabileste **parteneriat** de inovatie - productie , service si vanzare cu **MC Machinery Systems** care este divizia de masini unelte si tehnologii de prelucrare a **MITSUBISHI Corporation**.



| ABKANT HIDRAULIC
CNC |



| GHILOTINA HIDRAULICA
CNC |



| ABKANT SERVO
ELECTRIC CNC |



| ABKANT SERVO-ELECTRIC
CU SURUB CNC |



| MASINI CNC
DEBITAT CU LASER |



| MASINI CNC
DEBITAT CU PLASMA |



| STRUNGURI CNC
ORIZONTALE |



| CENTRE CNC VERTICALE
DE PRELUCRARE |

Turkey's Largest

Machine Production Facility

1.300.000 m² facilități totale de producție





Asistenta Tehnica
si
Service
oriunde in lume



PRESA SERVO ELECTRICA DE INDOIT TABLA TIP ABKANT CU CNC SERVOBRAKE DD-M-8025

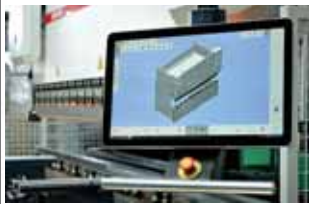

Controler grafic 3D cu ecran tactil 21" tip Windows ESA 875 W	Tampon spate axele Y1 Y2 X R (servomotoare)	Sistem antibombare CNC motorizat
		
Set 2 buc. brate frontale din aluminiu culisabile pe ghidaje liniare	Sistem protectie lateral si spate	Set 2 buc. tampoane deget culisabile pe ghidaje liniare pe traversa tamponului spate
Pedaliere de comanda cu intrerupator de urgenta	Sistem protectie laser DSP-AP + Modul PLC de siguranta MCS (manual)	Iluminare LED

€63800
€71324

CNCELECTRIC SERVOBRAKE

Lungime indoire	2550 mm
Forta indoire	80 tone
Viteza apropiere	90 mm/sec
Viteza lucru	20 mm/sec
Viteza ridicare	90 mm/sec
Cursa	300 mm
Putere motor	11 kW/400V
Greutate	6100 kg

FARA	ZGOMOT
	ULEIURI HIDRAULICE
	FILTRE HIDRAULICE
	GARNITURI HIDRAULICIE
	VALVE
	CILINDRII
	TIMPI MORTI DE LUCRU

Presele tip abkant servo electrice sunt cu 50% mai economice

Presele tip abkant servo electrice sunt cu 30% mai rapide

Presele tip abkant servo electrice ofera productivitate ridicata

Presele tip abkant servo electric ofera posibilitati de Indoire complexe



PRESA SERVO ELECTRICA CU SURUB DE INDOIT TABLA TIP ABKANT CU CNC DDS 2090

COD: DD-S-2090



DOTARE DDS 2090

Controler grafic CNC 2D ESA S 640	Pedaliere de comanda cu intrerupator de urgenta
Sistem protectie laser DSP-AP	Tampon spate 4 axe -Y1, Y2, X, R
Sistem protectie lateral si spate	Sistem prindere scule tip EUROPEAN

€36800
€40952

Lungime indoire	900 mm
Forta indoire	20 tone
Viteza apropiere	150 mm/sec
Viteza lucru	20 mm/sec
Viteza ridicare	150 mm/sec
Cursa	150 mm
Putere motor	3,8 kW/400V
Greutate	2000 kg



PRESA SERVO ELECTRICA CU SURUB DE INDOIT TABLA TIP ABKANT CU CNC DDS 40130

COD: DD-S-40130



DOTARE DDS 40130

Controler grafic CNC 2D ESA S 640	Pedaliere de comanda cu intrerupator de urgenta
Sistem protectie laser DSP-AP	Tampon spate 4 axe -Y1, Y2, X, R
Sistem protectie lateral si spate	Sistem prindere scule tip EUROPEAN

€47600
€54802

Lungime indoire	1300 mm
Forta indoire	40 tone
Viteza apropiere	150 mm/sec
Viteza lucru	20 mm/sec
Viteza ridicare	150 mm/sec
Cursa	150 mm
Putere motor	2x3,8 kW/400V
Greutate	3400 kg



PRESA HIDRAULICA TIP ABKANT CU CNC
SMART XL 40220 | SMART XL 30220 | SMART XL 30175 | SMART XL 26100 | SMART XL 2060



Incepand cu

€37129



Presele hidraulice tip abkant Dener SMART XL CNC sunt economice, puternice, precise si rapide. Se adreseaza intreprinderilor mici si mijlocii care realizeaza procese de indoire a foilor de tabla.

Posibile aplicatii: carcase, cutii, structuri 3D din table indoite; Printre industriile carora se adreseaza enumeram: automotive, electronica, electrica, alimentara, militara, etc.

AVANTAJE

✓ Rezultate precise in operatiunile de indoire	✓ Timpi redusi pentru schimbarea sculelor.
✓ Constructie solida.	✓ Costuri de productie reduce.
✓ Adancime gat si curse de lucru mari.	✓ Usor de intretinut si reparat.
✓ Silentioasa, puternica si rapida.	✓ Componente performante, brand-uri de renume.

DOTARE STANDARD



Controler grafic CNC 2D ESA S 640

- Ecran tactil de 15" TFT LCD HD
- Interfata grafica intuitiva tip HMI
- Dynamic RAM 1 GBytes
- Reprezentare 2D
- Programare 2D
- 4 port analog intrare + 2 iesire
- 2 RS-232 serial ports
- USB port 2 x USB 2.0
- Port Ethernet 1 x 10/100/1000Mbit
- Port 1 CANopen
- Meniu disponibil in 25 limbi

3 Axe de lucru (Y1, Y2, X), R manual



Brate suport fata cu reglare pe inaltime



Sistem protectie lateral si spate

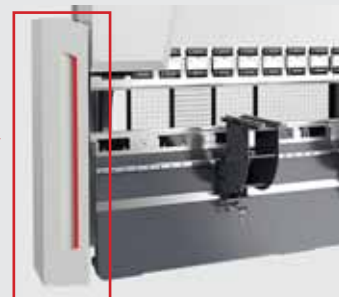

Adancime gat 450 mm (400 mm pentru SMARTXL2060)

PROMECAM
press brakes • tooling

Sistem prindere manual tip European

TECNOStamp

Scula tip European (Eurostamp_1281)
835 mm, Sectionata, H=104,65 mm $\alpha=85^\circ$



Pedaliere de comanda cu intrerupator de urgenta



Sistem protectie laser DSP-AP + Modul PLC de siguranta MCS (manual)



Iluminare LED

Tensiune de lucru 380 V, 50-60 Hz, 3 Ph

MODEL	SMARTXL40220	SMARTXL30220	SMARTXL30175	SMARTXL30135	SMARTXL26100	SMARTXL2060
Lungime indoire	4050 mm	3020 mm	3020 mm	3020 mm	2600 mm	2050 mm
Forta de indoire	220 tone	220 tone	175 tone	135 tone	100 tone	60 tone
Viteza de apropiere	140 mm/sec	140 mm/sec	150 mm/sec	160 mm/sec	160 mm/sec	180 mm/sec
Viteza de lucru	10 mm/sec	10 mm/sec	10 mm/sec	10 mm/sec	10 mm/sec	10 mm/sec
Viteza de ridicare	130 mm/sec	130 mm/sec	130 mm/sec	140 mm/sec	150 mm/sec	160 mm/sec
Cursa	350 mm	350 mm	350 mm	320 mm	300 mm	220 mm
Putere motor	22 kW/400V	22 kW/400V	22 kW/400V	15 kW/400V	11 kW/400V	7,5 kW/400V
Greutate	13200 kg	11100 kg	11000 kg	9150 kg	7800 kg	4700 kg
Pret lista	€76,247	€62,776	€59,016	€54,267	€44,464	€41,337
Pret Promotie	€ 68,486	€ 56,385	€ 53,800	€ 48,743	€ 39,950	€ 37,129



BEST SELLER

Livrare imediata din stoc

PRESA HIDRAULICA TIP ABKANT CU CNC FX 30200 | FX 30125 | FX 2680



Incepand cu
€34700

Presele hidraulice tip abkant Dener XF CN sunt economice, puternice, precise si rapide. Se adreseaza intreprinderilor mici si mijlocii care realizeaza procese de indoire a foilor de tabla.

Posibile aplicatii: carcase, cutii, structuri 3D din table indoite; Printre industriile carora se adreseaza enumeram: automotive, electronica, electrica, alimentara, militara, etc.

AVANTAJE

✓ Constructie solida.	✓ Usor de intretinut si reparat.
✓ Costuri de productie reduce.	✓ Silentioasa, puternica si rapida.

DOTARE STANDARD

Controler grafic
CNC 2D ESA S 640



- Ecran tactil de 15" TFT LCD HD
- Interfata grafica intuitiva tip HMI
- Dynamic RAM 1 GBytes
- Rezentare 2D
- Programare 2D
- 4 port analog intrare + 2 iesire
- 2 RS-232 serial ports
- USB port 2 x USB 2.0
- Port Ethernet 1 x 10/100/1000Mbit
- Port 1 CANopen
- Meniu disponibil in 25 limbi

3 Axe de lucru: X - cursa axa – 500 mm



Axele Y1, Y2



Adancime gat 300 mm

PROMECAM
press brakes • tooling

Sistem prindere manual tip European

TecnosStamp

Scula tip European (Eurostamp_1281)
835 mm, Sectionata, H=104,65 mm $\alpha=85^\circ$



Pedaliere de comanda cu intrerupator de urgenta



Sistem protectie laser DSP-AP
+ Modul PLC de siguranta MCS (manual)



MODEL	XF 30200	XF 30125	XF 2680
Lungime indoire	3020 mm	3020 mm	2600 mm
Forta indoire	200 tone	125 tone	80 tone
Viteza de apropiere	100 mm/s	100 mm/s	100 mm/s
Viteza de lucru	7.5 mm/s	10 mm/s	10 mm/s
Viteza de ridicare	80 mm/s	80 mm/s	80 mm/s
Putere motor	15 kW/400V	11 kW/400V	5.5-7.5 kW/400V
Greutate	8500 kg	7000 kg	5000 kg
COD	CNCDENERECOFX30200	CNCDENERECOFX30125	CNCDENERECOFX2680
Pret lista	€ 52,783	€ 45,363	€ 37,044
Pret Promotie	€ 47,800	€ 39,900	€ 34,700

POANSON L= 805F. MM 11.230F | POANSON 85° R 0.8 H105 L= 835 MM 11.230S | POANSON L= 415 MM 11.230M MATRITA 4 VEE L= 805F. MM 21.207F | MATRITA V16-V22-V35-V50 85° H 60 L= 835 MM 21.207S

TecnosStamp

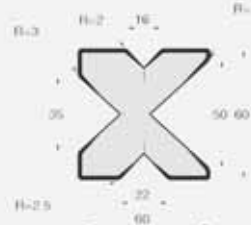

Model	11.230F	11.230S	11.230M	21.207F	21.207S	21.207M
Tip	Poanson	Poanson	Poanson	Matrita	Matrita	Matrita
Caracteristici	85°	85°	85°	4 VEE	V16-V22-V35-V50	4V
	R 0.8	R 0.8	R 0.8	L= 805F. mm	85°	L= 415 mm
	H105	H105	H105		H 60	
	L= 805F	L= 835 mm	L= 415 mm		L= 835 mm	
COD	11.230F	11.230S	11.230M	21.207F	21.207S	21.207M
Pret lista	€ 476	€ 329	€ 209	€ 523	€ 344	€ 222
Pret Promotie	€ 430	€ 297	€ 189	€ 471	€ 310	€ 200



Abkant electric - masina de indoit tabla XBend 6.1,50 + Controler cu ecran tactil + tampon spate electric 1000 mm + Rola taietoare motorizata XBEND 6.1,50 + BMS + TAZ + ROLA

COD: XBend6.1-50+CTSBMSTAZ1000564+PSBM36150200

biegemaster

Lungime indoire	6400 mm
Indoire / fasiere 400 N/mm ²	1.50 mm
Indoire / fasiere aluminiu 200 N/mm ²	2.00 mm
Numar standuri brate tensionare	5 buc.
Numar suporti articulati	5 buc.
Adancime limitator spate:	1000 mm
Putere utila	15 kW

Seria Biegemaster Xbend realizeaza indoiri ale tablei in regim complet automat.

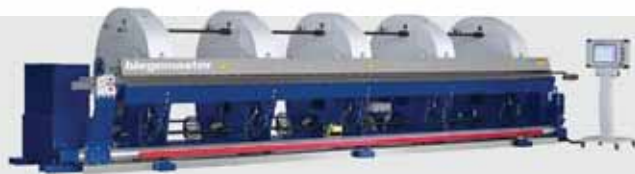

€312409
€323263



ECHIPAMENT INCLUS

Indoire automata in doua directii

Brate tensionare pentru indoire actionate hidraulic

Tampon spate electric 1000 mm

Rola taietoare motorizata

Controler cu ecran tactil

Masina de indoit tabla complet electrica BIEGEMASTER BENDTRON 6.1,50 + Controler cu ecran tactil + tampon spate electric 1000 mm + Rola taietoare motorizata BENDTRON 6.1,50+CTSBMSTAZ1000564+PSBM36125150

COD: BENDTRON6.1-50+BMSMTC+ABC+EC

biegemaster



Seria Biegemaster BenTron realizeaza indoiri ale tablei in prin angrenare complet electrica.

€151474
€156737



Lungime indoire	6400 mm
Capacitate	
Indoire / fasiere 400 N/mm ²	1.50 mm
Indoire / fasiere aluminiu 200 N/mm ²	2.00 mm
Numar standuri brate tensionare	6 buc.
Numar suporti articulati:	6 buc.
Adancime limitator spate:	1000 mm
Putere utila	6 kW



ECHIPAMENT INCLUS

Indoire controlata electrocinetic

Falca indoire cu geometrie optimizata

Controler cu ecran tactil

Tampon spate electric 1000 mm

Rola taietoare motorizata

Abkant electric - masina de indoit tabla BENDTRON 6.1,50 + Controler cu ecran tactil + tampon spate electric 1000 mm + Rola taietoare motorizata DURA 6.1,50 hydr.+CTSBMSTAZ1000564+PSBM36125150

COD: DURA6.1-50hydr.+BMSMTC+ABC+EC

biegemaster



Seria Biegemaster BenTron realizeaza indoiri ale tablei in prin angrenare hidraulica.

€132905
€137523



Lungime indoire	6200mm
Indoire / fasiere 400 N/mm ²	1.50 mm
Indoire / fasiere aluminiu 200 N/mm ²	2.00 mm
Numar standuri brate tensionare	7 buc.
Numar suporti articulati	7 buc.
Adancime limitator spate:	958 mm
Putere utila	4 kW



ECHIPAMENT INCLUS

Indoire controlata hidraulic

Falca indoire reglabila

Controler cu ecran tactil

Tampon spate electric 1000 mm

Rola taietoare motorizata

ABKANT ELECTRIC UNIM 2S 40/10

COD: HMTUNIM2S40/10



Seria UNIM de abkanturi combina in mod util atat avantajele oferite de catre masinile motorizate, cat si de masinile manuale. Falca de presare este actionata manual, iar falca de indoire este actionata prin motor electric.



€19900
€24525

Lungime indoire	4020 mm
Grosime max. otel 400N	1,00 mm
Grosime max. inox 600N	0,60 mm
Grosime max. aluminiu 275N	1,50 mm
Deschidere	140 mm
Putere motor	1,1 kW
Greutate	2600 kg

ECHIPAMENT STANDARD



Reglare manuala a unghiului de indoire



Reglare traversa indoire conform cu grosimea materialului



Comanda la pedala

Cutit traversa superioara la 20°

Cutit traversa indoire 20 mm

Maneta de blocare falca superioara

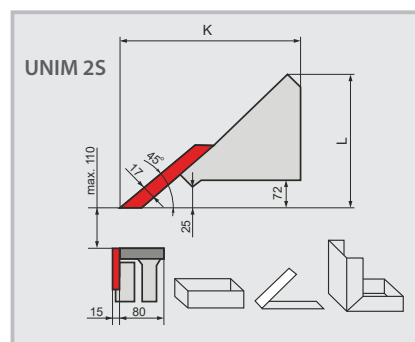

ABKANT ELECTRIC DOH-6E | DOH-4E

COD: DOH-6E | DOH-4E

Bří ŠVARCOVÉ s.r.o.



- Masina a fost contruita pentru a fi **simplic de utilizat si eficienta**
- Falca de presare este controlata din panoul de comanda fiind **actionata electro-mecanic**.
- Forta aplicata barei superioare este reglabila
- Permite indoirea materialelor din **aluminiu, titan-zinc, cupru** sau **tabla galvanizata**
- Foarte utila in domeniul **construcțiilor metalice si productia de hale, productia de acoperisuri, pervaze, jgheaburi**, pentru **comerțiantii de materiale constructii**

Incepand cu
€22130



DOTARI



Limitator cursa

Scala gradata

Date tehnice	DOH-6E	DOH-4E
Lungime indoire	6000 mm	4000 mm
Grosime max.otel	0.8 mm	1 mm
Adancime de lucru	1000 mm	1000 mm
Unghi maxim indoire	150°	150°
Greutate	1430 kg	1010 kg
COD	DOH-6E	DOH-4E
Pret lista	€34,337	€27,367
Pret promotie	€ 27,767	€ 22,130

ABKANT ELECTRIC ZGM-3000-1.25

COD: ZGM-3000-1.25



Latime de lucru	3100 mm
Grosime tabla	1,25 mm
Unghi max. indoire	135°
Putere motor	2x2,2 kW/400 V
Greutatea:	1750 kg
Putere utila	4 kW

Avantaje:

- ✓ Ciclu automat care scurteaza munca cu 25%
- ✓ Grinda de presare si grinda de Indoire
- ✓ Design ergonomic
- ✓ Reglarea razei de indoire
- ✓ Tampon spate cu limitator
- ✓ Reglare viteza deplasare grinzii indoire

€19900
€23465



ABKANT MANUAL SEGMENTAT ROP-15/1260

COD: 25373124



Lungime indoire	1260 mm
Grosime max. tabla	1.5 mm
Unghi max. indoire	135 °
Greutate	133 kg

Stoc limitat!

€1161
€1301



ABKANT MANUAL SEGMENTAT CCM 2050

COD: CCM2050



Lungime indoire	2060 mm
Grosime max. tabla	2 mm
Unghi max. indoire	135 °
Greutate	1250 kg

€6950
€7589



ABKANT MANUAL SEGMENTAT ROP-20/1020N | ROP-20/1270N

COD: 25031003 | 25031270



Stoc limitat!



Inceand cu
€1850



MODEL	ROP-20/1270N	ROP-20/1020N
Lungime indoire	1270 mm	1020 mm
Grosime max. tabla	2 mm	2.5 mm
Unghi max. indoire	135 °	135 °
Greutate	350 kg	285 kg
COD	25031270	25031003
Pret lista	€2,915	€2,416
Pret Promotie	€2,350	€1,850

ABKANT MANUAL ZG-3000 / 1.0 | ZG-2000 / 1.5 | ZG-2000 / 1.2 ROLA TAIETOARE NK-1.2 | NK-0.8



Inceand cu
€1880

MODEL	ZG-3000-1.0	ZG-2000-1.5	ZG-2000-1.2
Lungime indoire	3100 mm	2100 mm	2150 mm
Grosime max. tabla	1 mm	1,5 mm	1.2 mm
Unghi max. indoire	130 °	135°	130°
Greutate	700 kg	320 kg	250 kg
COD	ZG-3000-1.0	ZG-2000-1.5	ZG-2000-1.2
Pret lista	€4,509	€2,479	€1,938
Pret Promotie	€4,280	€2,380	€1,880



Inceand cu
€377



Rola taietoare	1.2 mm	0.8 mm
COD	NK-1.2	NK-0.8
Pret lista	€582	€403
Pret Promotie	€475	€377



HIDROLIKSAN

HALIM USTA

Cu experienta de peste 40 de ani in dezvoltarea si productia de prese hidraulice, HIDROLIKSAN dezvolta permanent concepte tehnologice noi si exporta produsele sale in peste 40 de tari ale lumii, in special Europa, Orientul Mijlociu, Africa de Vest si Asia.



Prese Dublu Efect



Prese SMC



Prese Ambutisat tip C



Prese Ambutisat tip H



Prese Hidraulice Planat Tabla



Prese cu Coloana tip H



Prese Hidraulice Universale



Prese Hidraulice de Atelier



The Name of Hydraulic Power

PRESA HIDRAULICA TIP C DE AMBUTISAT CU SIMPLU EFECT CFSS 100

DOTARE STANDARD

COD: CFSS100

Cilindri de actionare sunt cromati	Forta presare	1000 kN
Cadru masinii este din otel sudat	Dimensiuni masa	800x500 mm
Panou de control tactil de tipul HMI (Human-Machine Interface)	Cursa	400 mm
Grilaje laterale pentru protectie si sistem de protectie cu bariera de lumina	Distanta masa-berbec	500 mm
Pedaliere de comanda cu dubla actionare	Putere motor	11 kW
Viteza, cursa, presiune reglabile din panoul de control	Greutate	5500 kg
Manometru presiune ulei	Sistem de racire	
	Masa cu canale T	



€59000
€69960

Forta presare	2500 kN
Distanta intre coloane (D)	1300 mm
Distanta intre coloane (E)	450 mm
Distanta masa-berbec (H)	900 mm
Cursa berbec	400 mm
Putere motor	15 kW/400V
Dotari standard	cu motor

PRESA HIDRAULICA PENTRU ATELIERE MECANICE HD 250

COD: HD250M1300



€19721
€20724



Dotare standard:

- ✓ Cilindri de actionare sunt cromati
- ✓ Cadru masinii este din otel sudat
- ✓ Manometru presiune ulei
- ✓ Sistem de reglare a presiunii

PRESA HIDRAULICA PENTRU ATELIERE MECANICE HD 160 MOV 1550 | HD 100 MOV1010 | HD 60 MOV820



Incepend cu
€5264

MODEL	HD 160 MOV 1550	HD 100 MOV1010	HD 60 MOV820
Forta presare	1600 kN	1000 kN	600 kN
Distanta intre coloane (D)	1550 mm	1010 mm	820 mm
Distanta intre coloane (E)	550 mm	300 mm	300 mm
Distanta masa-berbec (H)	900 mm	900 mm	900 mm
Cursa berbec	400 mm	400 mm	400 mm
Putere motor	5,5 kW/400V	4 kW/400V	3 kW/400V
Dotari standard	cu motor, pompa manuala si cilindru deplasabil		
COD	HD160MOV1550	HD100MOV1010	HD60MOV820
Pret lista	€11,731	€7,259	€5,532
Pret Promotie	€ 9,900	€ 6,580	€ 5,264

Stoc limitat!



PRESA HIDRAULICA PENTRU ATELIERE MECANICE HP-1000 | HP-800 | HP-300



Inceand cu
€3285

MODEL	HP-1000	HP-800	HP-300
Forta presa	1000 kN	800 kN	300 kN
Presiune max. lucru	263 bar	255 bar	244 bar
Cursa berbecului	300 mm	250 mm	200 mm
Diametrul brat piston	Ø 220x160 mm	Ø 200x120 mm	Ø 125x80 mm
Viteza de presare	5 mm/sec	5 mm/sec	5 mm/sec
Putere motor	5,5 kW	5,5 kW	3 kW
Greutate	1500 kg	835 kg	400 kg
Dotari standard	• Manometru presiune • Valve siguranta prevenire suprasarcinii • Prisma-V • Sistem ajustare contiuna a mesei de lucru pe verticala • Maneta control viteza de apropiere si operarea la viteze mici		
COD	127480-1	HP-800	HP-300
Pret-lista	€7,187	€6,684	€5,025
Pret Promotie	€ 6,552	€ 4,900	€ 3,285

HP-1000	GARANTIE 24 Luni	TRANSPORT GRATUIT	PIF GRATUIT	ACHIZITIE INTRACOMUNITARA	
HP-800	GARANTIE 24 Luni	TRANSPORT GRATUIT	PIF GRATUIT	3-6 RATE	ACHIZITIE INTRACOMUNITARA
HP-300	GARANTIE 24 Luni	TRANSPORT GRATUIT	ASISTENTA DE LA DISTANTA	3-6 RATE	

Stoc limitat!



Stoc limitat!

PRESA HIDRAULICA PENTRU ATELIERE MECANICE HLR-50U/2A | HLR-20U/2 | HLR-12U/2 | HLR-10U/2



Inceand cu
€280

HLR-50U/2A	GARANTIE 24 Luni	TRANSPORT GRATUIT	ASISTENTA DE LA DISTANTA	ACHIZITIE INTRACOMUNITARA
HLR-20U/2	GARANTIE 24 Luni	TRANSPORT GRATUIT	ASISTENTA DE LA DISTANTA	
HLR-12U/2	GARANTIE 24 Luni	TRANSPORT GRATUIT	ASISTENTA DE LA DISTANTA	
HLR-10U/2	GARANTIE 24 Luni	ASISTENTA DE LA DISTANTA		

MODEL	HLR-50U/2A	HLR-20U/2	HLR-12U/2	HLR-10U/2
Forta de presare	500 kN	200 kN	120 kN	100 kN
Cursa de lucru	68 - 1048 mm	54 - 1044 mm	0 - 910 mm	0 - 340 mm
Diametru berbec	65 mm	46 mm	40 mm	40 mm
Inaltime	1904 mm	1805 mm	1375 mm	760 mm
Greutate	365 kg	132 kg	83 kg	50 kg
COD	25000057	25000055	25000054	25000053
Pret-lista	€2,192	€799	€397	€332
Pret Promotie	€ 1,956	€ 695	€ 335	€ 280

Stoc limitat!

Stoc limitat!

Stoc limitat!

PRESA HIDRAULICA PENTRU ATELIERE MECANICE P001/75 | P001/30 | P001/30



P001/75	GARANTIE 24 Luni	TRANSPORT GRATUIT	ASISTENTA DE LA DISTANTA	ACHIZITIE INTRACOMUNITARA
P001/30	GARANTIE 24 Luni	TRANSPORT GRATUIT	ASISTENTA DE LA DISTANTA	
P001/04	GARANTIE 24 Luni	ASISTENTA DE LA DISTANTA		

Inceand cu
€275

MODEL	P001/75	P001/30	P001/04
Forta presa	750 kN	300 kN	40 kN
Suprafata de lucru	800 x 279 x 850 mm	525 x 290 x 980 mm	350 x 115 x 325 mm
Diametru berbec	Ø 125 mm	Ø 92 mm	Ø 40 mm
Cursa berbec	250 mm	160 mm	125 mm
Greutate presa	498 kg	148 kg	29 kg
COD	P001/75	P001/30	P001/04
Pret-lista	€4,801	€1,031	€312
Pret Promotie	€ 4,405	€ 928	€ 275

ELMALI MACHINERY (Turcia), cu o vechime de 35 ani in productia de masini pentru prelucrarea tablei, ELMALI beneficiaza de o linie de productie moderna capabila sa deserveasca cererea din peste 50 de tari, 65% din productia sa fiind orientata catre export, din Germania pana in Arabia Saudita. Valorile pe care ELMALI le promoveaza sunt calitatea si longevitatea produselor, grad ridicat de tehnologie inglobata in utilajele sale, pret echitabil, suport post-vanzare.



Presele cu excentric tip C, seria EEP-PK cu cuplaj pneumatic si frana rapida, sunt construite din subansamble sudate si detensionate, prelucrate prin aschiere pe masini unelte de inalta precizie. Acestea cat si un montaj atent controlat, ofera utilajului robustete si fiabilitate.

PRESA CU EXCENTRIC TIP C, CUPLAJ PNEUMATIC EEP-PK 100



€55063
~~€67252~~



PRESA CU EXCENTRIC TIP C, CUPLAJ PNEUMATIC EEP-PK 60 | EEP-PK 40 | EEP-PK 25



Incepend cu
€25700

MODEL	EEP-PK100	EEP-PK60	EEP-PK40	EEP-PK25
Forta presa:	1000 kN	600 kN	400 kN	250 kN
Distata berbec masa	450 mm	360 mm	340 mm	300 mm
Dimensiune masa	600x780 mm	520x720 mm	440x630 mm	375x570 mm
Cadenta	50 batai/min	55 batai/min	55 batai/min	120 batai/min
Putere motor	11 kW/400V	4 kW/400V	4 kW/400V	3 kW/400V
Greutate	4650 kg	2750 kg	2100 kg	1300 kg
Dotari standard	<ul style="list-style-type: none"> • Controler PLC • Batiu din otel sudat-detensionat • Piese mari din otel turnat • Sistem combinat ambreiaj mecanic si frana • 4 ghidaje de culisare • Pene de reglare • Dispozitiv siguranta mecanica la suprasarcina • Masa principala cu canale T • Masa suplimentara cu canale T • Comanda la picior sau controler 2 maini • Sistem de ungere centralizat • Contor batai electronic 	<ul style="list-style-type: none"> • Batiu din otel sudat-detensionat • Piese mari din otel turnat • Sistem combinat ambreiaj mecanic si frana • 4 ghidaje de culisare • Pene de reglare • Dispozitiv siguranta mecanica la suprasarcina • Masa principala cu canale T • Masa suplimentara cu canale T • Buton si pedala de comanda mobila • Sistem de ungere centralizat • Sistem electric si tablou de forta 		
COD	EEP-PK100	EEP-PK60	EEP-PK40	EEP-PK25
Pret lista	€67,252	€49,046	€40,550	€30,840
Pret Promotie	€ 55,063	€ 40,156	€ 33,200	€ 25,700

PRESA ORIZONTALA HIDRAULICA PP200CNC

COD: 100-16-01-001



NARGESA®



€10860
~~€11591~~



BEST SELLER

AVANTAJE

- **Panou de control:** Intuitiv, tehnologie 4.0.
- **Mod ECO economisește energie și contribuie la conservarea mediului.**
- **Manipulare usoară:** fiind plug & work
- **Scule incluse:** Presa orizontală PP200 include matrită 4V.
- **Versatilitate:** gama diversificată de scule opționale.
- **Fabricare usoară a sculelor:** clientul însuși sau orice producător de scule poate realiza matritele și poansoanele.
- **Schimbare rapidă a uneltelor, poansoanelor și matritelor:** Această schimbare nu durează mai mult de **30 de secunde**.

Putere lucru	20.000 Kg (200 KN).
Viteza lucru	9,8 mm/s.
Cursa maxima	245 mm.
Repetitivitate	0,05 mm.
Marime banc	600x1170 mm.
Inaltime lucru	950 mm.
Putere motor	2.2 KW la 1400 r.p.m.
Tensiune electrica	230/400 V
Greutate:	625 kg.

CONTROL CNC ESA S625

- Ecran tactil color de 7"
- **Tehnologie 4.0.**
- Stocare de până la 10.000 de programe.
- Programarea a 50 de unghiuri diferite la aceeași piesă.
- Programare în mm sau inci.
- Biblioteca de matrite și pumni.
- Programare în peste 20 de limbi.
- Control automat al unghiului de îndoire în grade.
- Mod de operare manual sau automat.
- Contor piese.
- Avertizare automată de întreținere preventivă.
- Conexiune la distanță inclusă.



PRESE MANUALE P029/3 | P028/14 | P028/07

Stoc limitat!

FERVI



Incepand cu
€104

MODEL	P029/3	P028/14	P028/07
Forta presare	25 kN	20 kN	15 kN
Inaltime max piesa	250 mm	275 mm	230 mm
Diametru max. piesa	300 mm	180 mm	150 mm
Dimensiuni	450 x 200 x 870 mm	280 x 170 mm	210 x 122 mm
Greutate	60 Kg	18 kg	8.5 kg
COD	P029/3	P028/14	P028/07
Pret lista	€445	€240	€118
Pret Promotie	€335	€211	€104



PRESE MANUALE AP-5 | AP-2 | AP-1

PROMA

Livrare imediata din stoc



Incepand cu
€66.25

MODEL	AP-5	AP-2	AP-1
Forta presare	50 kN	20 kN	10 kN
Dimensiune max. piesa	470 mm	195 mm	140 mm
Inaltime piesa	860 mm	450 mm	320 mm
Dimensiuni talpa	630 x 280 mm	432 x 175 mm	268 x 128 mm
Greutate	157 kg	34 kg	15 kg
COD	25000005	25000002	25000001
Pret lista	€870	€189	€78,45
Pret Promotie	€690	€157	€66,25





Infiintata in anul 1953, SAHINLER Makina isi concentreaza capacitatile de productie catre utilajele pentru prelucrarea tablelor si produce masini de roluit tabla cu 3 role, masini de roluit tabla cu 4 role, masini bordurat tabla, prese hidraulice planat tabla, masini de roluit profile si foarfeci combinate.

In prezent SAHINLER se numara printre liderii producatori de astfel de masini, cu export in 85 de tari.



MASINA HIDRAULICA DE ROLUIT TABLA CU 4 VALTURI 4R HSS 25-280

COD: 4RHSS25-280



€ 69163
~~€ 72576~~

Lungime roluire	2550 mm
Capacitate roluire fara preindoire'	16 mm
Capacitate roluire fara preindoire"	12 mm
Capacitate roluire cu preindoire'	12 mm
Capacitate roluire cu preindoire"	10 mm
Valturile centrale	280 mm
Valturile laterale	220 mm
Putere motor	16.5 kW/400V
Greutate	9650 kg

Diam. min = rola superioara x5; "Diam. min = rola superioara x1,5

DOTARE STANDARD

Valturile laterale și cel superior deplasabile linear piramidal cu ajutorul pistoanelor hidraulice	Dispozitiv de roluit conic;
Protectie la suprasarcina;	Sistem hidraulic pentru echilibrare valt;
Valtul superior si valturile laterale actionate separat cu transmisie planetara;	Doua trepte de viteze pentru actionarea valturilor;
Afisaj digital 3 axe pentru pozitionarea valturilor;	Pupitru de comanda mobil;
Inel de inchidere actionat hidraulic-evacuare virole;	Valturi din otel conform normelor SAE 1050 (CK 45) rezistente la tensionare;

Cadrul masinii din constructie sudata;

MASINI HIDRAULICE DE ROLUIT TABLA CU 4 VALTURI 4R HS 30-220 | 4R HS 20-180 | 4R HS 15-150



Inceand cu
€25601

DOTARE STANDARD

Date tehnice	4RHS30-220	4RHS20-180	4RHS15-150
Lungime roluire	3100 mm	2050 mm	1550 mm
Capacitate roluire fara preindeoire'	7 mm	8 mm	6 mm
Capacitate roluire fara preindeoire"	5 mm	6 mm	4 mm
Capacitate roluire cu preindeoire'	5 mm	6 mm	4 mm
Capacitate roluire cu preindeoire"	3 mm	4 mm	3 mm
Valturile centrale	220 mm	180 mm	150 mm
Valturile laterale	160 mm	190 mm	130 mm
Putere motor	5.5 kW/400V	5.5 kW/400V	4 kW/400V
Greutate	5500 kg	3500 kg	2250 kg
COD	4RHS30-220	4RHS20-180	4RHS15-150
Pret lista	€47,035	€33,083	€27,119
Pret promotie	€44,917	€31,593	€25,601

Valturile laterale si cel superior deplasabile linear piramidal cu ajutorul pistoanelor hidraulice

Valtul superior si valturile laterale actionate separat cu transmisie planetara;

Afisaj digital 3 axe pentru pozitionarea valturilor;

Inel de inchidere actionat hidraulic-evacuare virole;

Pupitru de comanda mobil;

Cadrul masinii din constructie sudata;

Valturi din otel conform normelor SAE 1050 (CK 45) rezistente la tensionare;

Dispozitiv de roluit conic;

Doa trepte de viteze pentru actionarea valturilor;

MASINA HIDRAULICA DE ROLUIT TABLA CU 4 VALTURI 4RH 15-130 | 4RH 13-115



Inceand cu
€25031

DOTARE STANDARD

- Recomandat pentru roluirea foilor de tabla subtiri din aluminiu si inox
- Valturile laterale deplasabile cu ajutorul pistoanelor hidraulice;
- Valtul superior actionat separat cu transmisie planetara.
- Protectie la suprasarcina;
- Pupitru de comanda mobil;
- Cadrul masinii din constructie sudata;
- Sistem de ungere centralizat;
- Inel de inchidere actionat hidraulic-evacuare virole;

Date tehnice	4RH15-130	4RH13-115
Lungime roluire	1550 mm	1350 mm
Capacitate roluire fara preindeoire'	4 mm	4 mm
Capacitate roluire fara preindeoire"	3 mm	3 mm
Capacitate roluire cu preindeoire'	3 mm	3 mm
Capacitate roluire cu preindeoire"	2 mm	2 mm
Valturile centrale	130 mm	115 mm
Valturile laterale	110 mm	115 mm
Putere motor	3 kW/400V	3 kW/400V
Greutate	1760 kg	1685 kg
COD	4RH15-130	4RH13-115
Pret lista	€29,879	€26,516
Pret promotie	€28,206	€25,031

*Diam. min = rola superioara x5; *Diam. min = rola superioara x1,5



*Preturile sunt exprimate in EURO si nu contin T.V.A

MASINA DE ROLUIT TABLA ELECTROMECHANICA CU 3 VALTURI PSBE-2050-4/XS | PSBE-1550-3



PROMA

Inceand cu
€10300

Date tehnice	PSBE-2050-4/XS	PSBE-1550-3
Lungime roluire	2050 mm	1550 mm
Grosime tabla	4 mm	3 mm
Diametrul valturilor	140 mm	110 mm
Putere motor	2.2 kW	2.2 kW
Greutate	1350 kg	1200 kg
COD	126420-1	126340-1
Pret lista	€14,529	€12,578
Pret promotie	€ 13,715	€ 10,300



MASINA DE ROLUIT TABLA ELECTRICA CU 3 VALTURI PSBM-2050-2 | PSBM-1050-3



Inceand cu
€5800

PROMA



Date tehnice	PSBM-2050-2	PSBM-1050-3
Lungime roluire	2050 mm	1050 mm
Grosime tabla	1.5 mm	3 mm
Diametrul valturilor	95 mm	90 mm
Putere motor	1.5 kW/400V	1.1 kW/400V
Greutate	745 kg	480 kg
COD	126120-1	126040-1
Pret lista	€7,589	€6,382
Pret promotie	€ 6,919	€ 5,800

DISPOZITIV MANUAL DE ROLUIT TABLA CU 3 VALTURI PSBM-1050-3M | PSBM-1050-2M



Inceand cu
€2297

PROMA

Date tehnice	PSBM-1050-3M	PSBM-1050-2M
Lungime roluire	1050 mm	1050 mm
Grosime tabla	3 mm	2 mm
Diametrul valturilor	90 mm	75 mm
Greutate	410 kg.	300 kg.
COD	126170-1	126160-1
Pret lista	€ 4,874	€ 2,574
Pret promotie	€ 4,444	€ 2,297

DISPOZITIV MANUAL DE ROLUIT TABLA CU 3 VALTURI ZS-15/1300 | ZS-8/1000

DISPOZITIV MANUAL DE ROLUIT TABLA CU 3 VALTURI 0235

COD: 0235

FERVI



PROMA

Stoc limitat!

Inceand cu
€585

Date tehnice	ZS-15/1300	ZS-8/1000
Lungime roluire	1300 mm	1000 mm
Grosime tabla	1,5 mm	0,8 mm
COD	25374005	25374004
Pret lista	€ 1,545	€ 752
Pret promotie	€ 1,378	€ 585

COD: 25374005

COD: 25374004



BEST SELLER

Lungime roluire	300 mm
Grosime tabla	2,5 mm
Diametru rola	30 mm
Greutate	11 Kg

€195
€234



MASINA DE ROLUIT CU 2 ROLE PENTRU JGHEABURI SI BURLANE - FARA SERTIZARE SSL-PLC-6000

COD: SSL-PLC-6000

UMA d.o.o.



Latime tabla	6000 mm
Diametru jgheabu	160, 170, 180, 190, 200 mm
Diametru burlan	160, 170, 180, 190, 200 mm
Grosime max.	0,5-0,8 mm
Greutate	950 kg

€29050
€30986



MASINA ROLUIT BURLANE SI JGHEABURI, ELECTRICA ZW-2000/0.6

COD: ZW-2000-0.6

MARO



Latimea de lucru	2050 mm
Grosime max. tabla	0.6 mm
Diametrul rolor	2 x 90 mm, 1 x 70 mm
Diametru min. teava	100 mm
Putere motor	1,1 kW
Greutate	480 kg

€4472
€4779



UTILAJ ROLUIT MARGINEA BURLANULUI ZKP-2000

COD: ZKP-2000-J

MARO



Latime de lucru	2000 mm
Max. grosime tabla	0,6 mm
Diametru arbore	Ø 16 mm
Greutate	30 kg

€395
€497



Stoc limitat!



DISPOZITIV RULARE MARGINI JGHEABURI (WULTZ) ZK-2000

COD: ZK-2000

MARO



Latime de lucru	2000 mm
Max. grosime tabla	0,6 mm
Diametru arbore	Ø 16 mm
Greutate	18 kg

€380
€406



DISPOZITIV DE ROLUIT BURLANE SI CONFECTIONAT JGHEABURI KZ-2

COD: 469

Bři ŠVARCOVÉ s.r.o.



Lungime roluire	2020 mm
Grosime tabla	0,6 mm
Diametrul min. roluire	70 mm
Greutate	200 kg

€3457
€4064



UTILAJ PENTRU PRESAREA BURLANELOR (DE PRESAT SERTIZAT MARGINI) ZL-1A

COD: 446

Bři ŠVARCOVÉ s.r.o.



Lungimea de lucru	1000 x 2000 mm
Grosimea max tabla	0,8 mm
Diametrul min. interior	80 mm
Greutate:	80 kg

€990
€1410



Livrare imediata din stoc

UTILAJ DE DEROLARE A TABLEI - DEROLATOR OZ-1250/3

COD: 5261253

Bři ŠVARCOVÉ s.r.o.



Latime max. rola	1250 mm
Grosimea max tabla	0,8 mm
Greutate max. rola	3000 kg
Diam. int. rola	Ø 430 x 520 mm
Greutate:	140 kg

€3257
€3829



CARUCIOR - DEROLATOR PENTRU TABLA RD-150

COD: BRD150

Bři ŠVARCOVÉ s.r.o.



Distanta dintre role	260 mm
Latime max. rola	1250 mm
Greutate max. rola	150 kg
Greutate:	150 kg

€423
€739



Stoc limitat!

MASINA DE DEBITAT SI BORDURAT TABLA SDK-6

COD: SDK-6

Diametru max. tabla	4000 mm
Diametru min. tabla	440 mm
Inaltime max. bordurare	50 mm
Raza max. bordurare	35 mm
Grosime max. tabla inox	4 mm
Grosime max. tabla	6 mm
Putere motor	8 kW/400V
Greutate	2050 kg



DOTARE STANDARD

Set role bordurare (R25)

Role superioara si inferioara actionate independent prin motor electric

Role cutit taiat tabla

Cursa reglabila manual a capului de bordurat si a sistemului de prindere a tablei

Bordurarea si taierea se realizeaza pe acelasi cap

sahinler
METAL MAKINA ENDUSTRI A.S.



€41333
€43282

MASINA DE BORDURAT SI DECUPAT RMK-300 | RMK-250



Incepand cu

€4627

ROLE STANDARD RMK-300



ROLE STANDARD RMK-250



DOTARE STANDARD

Date tehnice	RMK-300	RMK-250
Lungime ax	300 mm	250 mm
Capacitate indoire	4 mm	2,5 mm
Diametru role	126 mm	96 mm
Adancime prelucrare	200 mm	160 mm
Viteza motor	12 rpm	16 rpm
Putere motor	2,2 kW/400V	1,5 kW/400V
Greutate	500 kg	350 kg
COD	126960-1	126950-1
Pret lista	€6,785	€5,075
Pret promotie	€ 5,900	€ 4,627

Rola superioara reglabila mecanic

Role din otel cu bucxse bronz

Motor cu sistem de franare

Actionare role de la pedaliar

Livrate cu postament

Set 4 role standard

PROMA

COD: 126950-1



COD: 126960-1



MASINA DE BORDURAT TABLA RMK-140



€2982
€3341

DOTARE STANDARD

COD: 126940-1

PROMA

Rola superioara reglabila mecanic

Role din otel cu bucxse bronz

Motor cu sistem de franare

Actionare role de la pedaliar

Livrate cu postament

Set 4 role standard

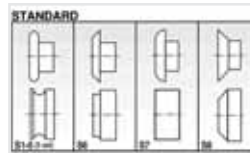

Lungimea axului	140 mm
Capacitatea de indoire	1,2 mm
Adancimea de prelucrare	100 mm
Viteza motor	32 rpm
Putere motor	0,75 kW/400V
Greutate	110 kg



DISPOZITIV DE BORDURAT RMK-125 | RMK-110



BEST SELLER

Incepand cu
€498



Rola superioara reglabila mecanic

Role din otel cu bucxse bronz

Livrare imediata din stoc

PROMA

Date tehnice	RMK-125	RMK-110
Lungime ax	125 mm	110 mm
Capacitate indoire	1,2 mm	0,8 mm
Adancime prelucrare	100 mm	80 mm
Greutate	50 kg	30 kg
COD	126930-1	126920-1
Pret lista	€929	€877
Pret promotie	€ 674	€ 498



MASINA DE DEBITAT TABLA CIRCULAR SRM-180

COD: 126890-1



DOTARE STANDARD

- Rama din fonta rigida
- Cutite otel cu reglare unghi taiere
- Cutite lagaruite cu bronz
- Taiere pe interior
- Sistem de ungere centralizat
- Motor cu sistem de franare
- Pupitru de comanda mobil



Diametru min. taiere	180 mm
Diametru max. tabla	1000 mm
Grosime max. tabla	2 mm
Viteza de lucru	7,5 m/min
Putere motor	1,1 kW/400V
Greutate	380 kg

€4969
~~€5578~~



MASINA DE DEBITAT TABLA CIRCULAR SRM-250



DOTARE STANDARD

- Rama din fonta rigida
- Cutite otel cu reglare unghi taiere
- Taiere pe interior
- Sistem hidraulic taiere si prindere tabla
- Sistem electromecanic fixare tabla
- Sistem de ungere centralizat



Diametru min. taiere	250 mm
Diametru max. tabla	2000 mm
Grosime max. tabla	5 mm
Viteza de lucru	4,5 m/min
Putere motor	2,2 kW/400V
Greutate	1350 kg

€15800
~~€17288~~

COD: 126910-1



FOARFECĂ GHILOTINĂ HIDRAULICĂ CU NC BS3106

COD: BSY3106



Stoc limitat!



Lungime taiere	3120 mm
Capacitate taiere	6 mm
Unghi de taiere	1,39°
Curse/minut	18
Putere motor	11 kW/400V
Greutate	6500 kg



€24724
~~€29668~~

- ✓ Constructie solida si durabila
- ✓ Standard de calitate ridicat, rapiditate in executie
- ✓ Control NC reglare distanta intre cutite si unghi taiere
- ✓ Precizie ridicata si usor de utilizat

- ✓ Costuri de intretinere reduse.
- ✓ Sisteme protectie in conformitate cu normele Europene
- ✓ Componente de calitate de la producatori de renume.
- ✓ Costuri de productie minime



FOARFECE GHILOTINE ELECTRICE PRGM-3060 | PRGM-2050 | PRGM-H-3060 | PRGM-H-2050

PROMA



Inceand cu
€22019



Inceand cu
€12631

SERIA PRGM

DOTARE STANDARD

- **Controler BRL NC**
- **Tampon spate motorizat** controlat NC de 750 mm
- Brate suport tabla fata
- Brat frontal pentru table lungi cu rigla
- Comanda la pedala
- Aparatoare in fata cutitului
- Masa cu bile pentru transport tabla
- Iluminat linia de taiere
- Verini antialunecare tabla

SERIA PRGM-H

DOTARE STANDARD

- **Tampon spate manual** de 750 mm
- Brate suport tabla fata
- Brat frontal pentru table lungi cu rigla
- Comanda la pedala
- Aparatoare in fata cutitului
- Masa cu bile pentru transport tabla
- Iluminat linia de taiere
- Verini antialunecare tabla

Stoc limitat!

MODEL	PRGM-3060	PRGM-2560	PRGM-2050	PRGM-H-3060	PRGM-H-2050
Lungime max. tabla	3050 mm	2550 mm	2050 mm	3050 mm	2050 mm
Grosime max. tabla	4 mm		2 mm		3 mm
Curse duble pe minut	41			35	
Latime masa	455 mm			390 mm	
Lungime tampon spate	750 mm				
Putere motor tampon spate	0,75 kW				
Putere motor electric	7,5 kW			4 kW	
Greutate	4010 kg	3510 kg	3010 kg	2210 kg	1760 kg
COD	127700-1	130520-1	127680-1	127690-1	130520-1
Pret lista	€28,499	€26,343	€23,325	€19,013	€13,599
Pret Promotie	€ 25,800	€ 24,868	€ 22,019	€ 17,948	€ 12,631



COD: 127700-1 | 130520-1 | 127680-1 | 127670-1



COD: 127690-1



FOARFECA GHILOTINA ELECTRICA NGM-2000/2.0



Inceand cu
€8450

- ✓ Limitator spate cu citire digitala (0 - 590 mm)
- ✓ Masurare unghi drept pe masa de lucru
- ✓ Aparatori in fata cutitului
- ✓ Reglarea diametru interior dintre cutite

Date tehnice	NGM-2000-2.0	NGM-2000-1.2
Lungime taiere	2050 mm	2050 mm
Grosime max. tabla	2,00 mm	1,25 mm
Unghi de lucru	1,5°	1,5°
Motor electric	3kW/400V	1,5 kW/400V
Greutate	1450 kg	500 kg
COD	NGM-2000-2.0	NGM-2000-1.2
Pret lista	€15,810	€8,833
Pret promotie	€ 13,800	€ 8,450



FOARFECA GHILOTINA MANUALA CU PARGHIE MGS-128 | MGS-128



Inceand cu
€2982

Date tehnice	MGS-128	MGS-128
Lungime taiere	1280 mm	1280 mm
Grosime tabla	2 mm	1,5 mm
Deschidere max. lama	0-600 mm	0-600 mm
Lungime masa	1565 mm	1565 mm
Greutate	510 kg	360 kg
COD	127640-1	127650-1
Pret lista	€3,868	€3,341
Pret promotie	€ 3,178	€ 2,982

COD: 127650-1



COD: 127640-1



BEST SELLER

Stoc limitat!

Utilizata in ateliere mici producatoare de tablouri electrice, cutii si panouri pentru energie solara, reparatii de capote de automobil, componente de racire si alte lucrari similare in metal.

FOARFECA GHILOTINA MANUALA CU PARGHIE MGS-105 | MGS-105



Inceand cu
€2589

COD: 127620-1



COD: 127630-1



Utilizata in ateliere mici producatoare de tablouri electrice, cutii si panouri pentru energie solara, reparatii de capote de automobil, componente de racire si alte lucrari similare in metal.

Stoc limitat!

Date tehnice	MGS-105	MGS-105
Lungime taiere	1050 mm	1050 mm
Grosime tabla	2 mm	1,5 mm
Deschidere max. lama	0-600 mm	0-600 mm
Lungime masa	1300 mm	1300 mm
Greutate	420 kg	320 kg
COD	127620-1	127630-1
Pret lista	€3,667	€3,122
Pret promotie	€ 2,589	€ 2,786

FOARFECA GHILOTINA MANUALA PRGM-1300M

COD: 130013



€4627
€5075

Lungime max. tabla	1320 mm
Grosime max. tabla	1,5 mm
Dimensiuni masa	330x1430 mm
Dimensiuni (LxIxH)	1680 x 560 x 1150 mm
Greutate	600 kg

- ✓ Tampon spate si lateral
- ✓ Protectie degete



DISPOZITIV MANUAL DEBITAT TABLA TRANSVERSAL SI LONGITUDINAL TK-1250

COD: TK-1250

Bří ŠVARCOVĚ s.r.o.



Latime max. rola	1250 mm
Grosime max. tabla	0.8 mm

- ✓ Debitare transversala cat si longitudinala a tablei dintr-o rola
- ✓ Constructia dispozitivului asigura pozitionarea si ghidarea precise ale tablei

€3448
€4053



FOARFECĂ GHILOTINĂ MANUALĂ CU PARGHIE ȘI MASĂ HS-500

COD: HS-500

PROMA



Lungimea de taiere	550 mm
Grosime tabla	1 mm
Dimensiuni masa	250x580 mm
Greutate	80 kg

€426
€504



LINEE PENTRU TUBULATURA RECTANGULARĂ MINI LINE

COD: ITEM-NO:7



- ✓ Cu aceasta linie integrată puteți obține o producție rapidă de tubulatură rectangulară, precisă, într-un spațiu de lucru restrâns și la costuri rezonabile.

€33068
€35023

Dimensiuni min. tubulatură	125 x 125 mm
Grosime tubulatură	0,5 - 1,25 mm, Aluminiu
	0,5 - 0,80 mm, Inox
Forma tubulatură	L, U și canal complet
Inchidere falt	Pittsburgh, Snaplock, Nulock
Capacitate de producție	800 m ² /zi (program de 8 ore)
Putere motor	2,2 kW
Greutate	2240 kg



UTILAJ ÎNCHIS FALT TUBULATURĂ RECTANGULARĂ SEAM CLOSER

COD: ITEM-NO:1



€15053
€15943

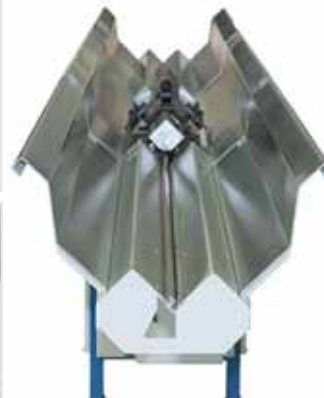

- ✓ Masina este ușor de operat și economică având un consum redus de energie

Grosime tabla	0,5 - 1,00 mm, tabla galvanizată 0,5 - 0,7 mm, Inox
Viteza lucru	5 m/min
Putere motor	3 kW/400 V
Greutate	640 kg

MASINA DE BORDURAT ȘI ÎNCHIS TUBULATURĂ RECTANGULARĂ PITTSBURGH SEAM CLOSER

COD: ITEM-NO:19



€9477
€10037



- ✓ Masina este ușor de operat și economică având un consum redus de energie

Lungime lucru	2100– 1250 mm
Grosime max. tabla	1.00 mm
Dimensiune min. piesa	105 x 105 mm
Viteza de lucru	15 m / min
Putere utila	0.75 kW/ 400V
Greutate	770 kg



www.proma.ro

*Prețurile sunt exprimate în EURO și nu conțin T.V.A.

MASINA FALTUIT TABLA PENTRU TUBULATURA VENTILATIE PITTSBURGH SI SNAPLOCK LOCK FORMER

COD: ITEM-NO:3



Grosime max.tabla	1,2 mm
Grosime max. inox	0,7 mm
Inaltime max. inchidere	20 mm
Viteza avans	15 m/min
Putere motor	3 kW/400V
Greutate:	410 kg

€10335
€10946

- ✓ Poate forma faltul tip Pittsburgh si tip Snaplock.
- ✓ Masina cu 9 statii de lucru.
- ✓ Livrata cu 2 seturi de role.



MASINA DE BORDURAT PITTSBURG SI SNAPLOCK FLANGING MACHINE



COD: ITEM-NO:2



Dimensiuni min. tubulatura	125 x 125 mm
Grosime tubulatura	0,5 - 1,25 mm, Aluminiiu
	0,5 - 0,80 mm, Inox
Forma tubulatura	L, U si canal complet
Inchidere falt	Pittsburgh, Snaplock, Nulock
Capacitate de productie	800 m2/ zi (program de 8 ore)
Putere motor	0.55 kW
Greutate	200 kg

- ✓ Bordureaza marginile tablei pentru a realiza profilul "tata" Pittsburgh si Snaplock
- ✓ Simpla de utilizat si ergonomica

€5220
€5494



MASINA DE TAIAT PROFILE PENTRU TUBULATURA RECTANGULARA FLANGE CUTTING

COD: ITEM-NO:21

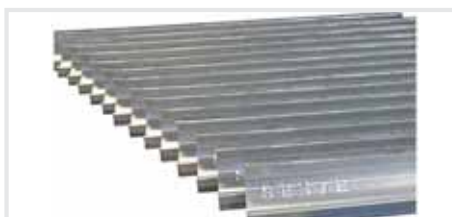

€4356
€4586

- ✓ Taie profile de tubulatura rectangulara la lungimea dorita
- ✓ Cu ajutorul riglei de 1500 mm executa o taiere precisa si fara bavura.

Lungime rigla debitare	1500 mm
Putere motor	1,5 kW
Dimensiuni	550 x 550 x 780 mm
Greutate:	105 kg

MASINA DE TAIAT CU PLASMA GEKA GCS P-3015 + sursa Hypertherm 105A+ PRONEST 2021 LT SOFTWARE

COD: PL315C3CNH5P



Sursa Hypertherm 105A
Taiere 32 mm (500 mm/min)
Retezare 50 mm 125 mm/min
Perforare 22 mm



SOFTWARE PRONEST 2021 LT
program software de analiza pentru programarea debitarii mecanizate a pieselor, in regim industrial usor.

€44800
€53070

- ✓ Preventie la coliziune a capului de taiere.
- ✓ Sistem de transmisie cu cremaliera si pini-on, anghrenare cu servo motoare
- ✓ Preventie la coliziune a capului de taiere

Sistem complet de filtrare

Dimensiuni taiere	1500 x 3000 mm
Inaltimea podului	Z=100mm
Capacitate taiere max	32 mm
Viteza de avans	40 m/min.
Greutate	1500 kg.

*Preturile sunt exprimate in EURO si nu contin T.V.A

www.proma.ro

MASINA DE SANFRENAT TABLA COMPACT EDGE

COD: 03-400-100-10004

G.B.C.
Industrial Tools S.p.A



Grosime tabla	6 ÷ 60 mm
Unghi sanfrenare	15° ÷ 60°
Latime min. tabla	70 mm
Viteza de lucru	1,6 m/min
Putere utila motor	3 kW/380V
Greutate	143 kg

- ✓ Materiale prelucrabile: otel carbon, inox, duplex, super duplex, laminat inconel, aluminiu etc
- ✓ Echipata cu senzor detectie tabla si conveyor span
- ✓ Motorul masinii este dotat cu inverter pentru reglare usoara unghi sanfrenare

€14829
€16013



MASINA DE SANFRENAT TABLA IN X DUBLA SANFRENARE UZ-50

COD: 1940

N.E.O.
MACHINES



Grosime tabla	7 ÷ 80 mm
Unghi sanfrenare	20°-60°
Dimensiuni min. material	200 x 100 x 7 mm
Latime max. sanfrenare	62 mm
Viteza de lucru	1.2 m/min
Putere motor	4 kW/380V
Greutate	175 kg

- ✓ Dubla sanfrenare de tip X,
- ✓ Prelucraza in mod eficient otelul, inoxul, tabla, otel HARDOX, tabla laminata la cald DOMEX si aluminiu
- ✓ Dotata cu sistem automat cu inverter pentru avansul materialului
- ✓ Permite sanfrenarea continua a tablei fara oprirea acestuia si inlocuirea frezei

€13900
€16736



MASINA DE SANFRENAT TABLA UZ-15 | CARUCIOR 3D PENTRU MASINA DE SANFRENAT UZ-15 3D UZ -15

COD: 1931

COD: 1930

N.E.O.
MACHINES



Grosime tabla	6 ÷ 40 mm
Unghiuri sanfrenare	15-50°
Latime max. sanfrenare	15 mm
Viteza de lucru	3.5 m/min
Putere motor	1,5 kW/380V
Greutate	94 kg



- Carucior 3D pentru UZ-15:
- ✓ Permite sanfrenuri cu doua fete X K.
 - ✓ Fara nevoia de macara pentru a roti materialul.
 - ✓ Permite economisirea unui timp de lucru semnificativ.

€6450
€7591

€2900
€3934



MASINA DE SANFRENAT TABLA PORTABILA B22 ZERO 220V

COD: 29220

€1729
€1812

N.E.O.
MACHINES



Latime max. sanfrenare	20 mm
Reglare unghi	0° - 60°
Putere motor	1,1 kW/220V
Turartii	2850 rpm.
Greutate	21 kg

- ✓ Masina portabila
- ✓ Poate prelucra marginile la 0° pentru a elimina bavura dupa taierea cu plasma sau oxigen.
- ✓ Design compact si ergonomic permite obtinerea unei productivitati ridicate in timpul muncii.



MASINA DE FASONAT OTEL-BETON DIGITALA BD45 | BSD36 | BD36



Incepan cu
€4322

COD: 127120-1

COD: 127120-2



COD: 151420-1



MODEL		BD45	BSD36	BD36
		2 ghidaje	4 ghidaje	2 ghidaje
Fasonare 1 fir	otel 45 kg	45 mm	36 mm	36 mm
	otel 65 kg	40 mm	32 mm	32 mm
	otel 85 kg	32 mm	26 mm	26 mm
Fasonare 2 fire	otel 45 kg	30 mm	20 mm	20 mm
	otel 65 kg	26 mm	18 mm	18 mm
	otel 85 kg	20 mm	14 mm	14 mm
Putere motor		4 kW/380V	3 kW/380V	3 kW/380V
Greutate		478 kg	450 kg	450 kg
COD		151420-1	127120-2	127120-1
Pret lista		€6,607	€5,451	€4,911
Pret Promotie		€ 5,814	€ 4,797	€ 4,322

- ✓ Se adreseaza lucrarilor de case, vile, parter+etaj
- ✓ Fasonare-confectionare etrieri, in regim manual sau automat.
- ✓ Fasonarea prin rotirea placii de indoit stanga-dreapta;
- ✓ Ajustarea unghiului de lucru se face prin intermediul panoului de control digital, tip LCD
- ✓ Pana la 9 programe de lucru, fiecare program putand efectua pana la 9 indoiri;
- ✓ Counter digital pentru indoiri

MASINA DE FASONAT OTEL BETON B45 | B36



Incepan cu
€3650

**BEST
SELLER**



MODEL		B45	B36
		2 ghidaje	2 ghidaje
Fasonare 1 fir	otel 45 kg	45 mm	36 mm
	otel 65 kg	40 mm	32 mm
	otel 85 kg	32 mm	26 mm
Fasonare 2 fire	otel 45 kg	30 mm	20 mm
	otel 65 kg	26 mm	18 mm
	otel 85 kg	20 mm	14 mm
Putere motor		4 kW/380V	2.2 kW/380V
Greutate		430 kg	350 kg
COD		127100-1	127090-1
Pret lista		€4,891	€4,333
Pret Promotie		€ 4,380	€ 3,650

Livrare imediata
din stoc

COD: 127090-1



COD: 127100-1



- ✓ Se adreseaza lucrarilor de constructie a imobilelor
- ✓ Fasonarea prin transfer mecanic de energie;
- ✓ Ajustarea unghiului se realizeaza prin sistemul electric automatizat;
- ✓ Masina poate realiza indoiri atat in regim automat cat si manual;
- ✓ Sens de lucru stanga-dreapta.

*Preturile sunt exprimate in EURO si nu contin T.V.A

www.proma.ro

MASINA DE FASONAT OTEL BETON P38 EVO



COD: P38TTF01



€3990
€4373



Fasonare 1 fir	otel 65 kg	34 mm
	otel 85 kg	32 mm
Fasonare 2 fire	otel 65 kg	26 mm
	otel 85 kg	24 mm
Fasonare 3 fire	otel 65 kg	20 mm
	otel 85 kg	18 mm
Putere motor	3 kW/380V	
Greutate	365 kg	

MASINA COMBINATA DE DEBITAT SI FASONAT OTEL BETON TP40/46 EVO

COD: TP4046TTF01



Stoc limitat!



- ✓ Functionalitate si performanta excelente
- ✓ Sens de lucru stanga-dreapta.
- ✓ Mobilitate prin dotarea masinii cu roti pentru deplasare

€5956
€6964

Fasonare 1 fir	otel 65 kg	36 mm	Debitare 1 fir	38 mm
	otel 85 kg	30 mm		32 mm
Fasonare 2 fire	otel 65 kg	25 mm	Debitare 2 fire	28 mm
	otel 85 kg	20 mm		22 mm
Fasonare 3 fire	otel 65 kg	20 mm	Debitare 3 fire	22 mm
	otel 85 kg	16 mm		18 mm
Putere motor	5.5 kW/380V			
Greutate	365 kg			

MASINA DE FASONAT OTEL BETON MG20B



Fasonare 1 fir	otel 45 kg	20 mm
	otel 65 kg	16 mm
	otel 85 kg	14 mm
Fasonare 2 fire	otel 45 kg	14 mm
	otel 65 kg	12 mm
	otel 85 kg	10 mm
Putere motor	1.1 kW/380V	
Greutate	95 kg	



COD: 152000-1

- ✓ Compacta, rapida, puternica
- ✓ Fasonarea prin transfer mecanic de energie;

€2215
€2482



MASINA COMBINATA DE DEBITAT SI FASONAT OTEL BETON MAX-40



COD: MAX-40



Fasonare 1 fir	otel 45 kg	36 mm	Debitare 1 fir	36 mm
	otel 65 kg	32 mm		32 mm
	otel 85 kg	26 mm		28 mm
Fasonare 2 fire	otel 45 kg	20 mm	Debitare 2 fire	24 mm
	otel 65 kg	18 mm		20 mm
	otel 85 kg	14 mm		18 mm
Putere motor	Fasonare 2.2 kW		Debitare 3 kW/380V	
Greutate	540 kg			



€5391
€5913

MASINA DEBITAT OTEL-BETON HIDRAULICA H38



BEST SELLER

€2980
€4088



Debitare 1 fir	45 kg	38 mm
	65 kg	36 mm
	85 kg	32 mm
Debitare 2 fire	45 kg	26 mm
	65 kg	22 mm
	85 kg	20 mm
Putere motor	3 kW/380V	
Greutate	273 kg	

Stoc limitat!



COD: 127150-1

- ✓ Sunt actionate hidraulic si sunt prevazute cu arcuri de compensare.
- ✓ Dotate cu role de transport permite deplasarea rapida in interiorul santierului, la locul lucrarii
- ✓ Consumul redus de energie, precum si presiunea de lucru scazuta le recomanda ca fiind masini silentioase, sigure si cu impact redus asupra mediului.

CHEIE ELECTRICA DE FASONAT SI INDREPTAT OTEL BETON PR32 | MU16P 18V C | MU16P FOARFECA ELECTRICA DEBITAT OTEL BETON T32N

EDILGRAPPA

COD: 15001916



Inceand cu
€1986



COD: 15003266
COD: 15001100
COD: 15002904



Pret lista	€4,419	€2,654	€2,304	€3,391
Pret Promotie	€3,750	€2,287	€1,986	€2,922
MODEL	PR32	MU16P 18V C	MU16P	T32N
Diametru max.	32 mm	16 mm	16 mm	32 mm
Putere motor electric	1,1 kW	-	1,1 kW	1,4 kW
Greutate	26,4 kg	10,7 kg	12 kg	27 kg
COD	15002904	15003266	15001100	15001916

MASINA DE CONFECTIONAT ETRIERI SL30 | SL36



COD: 152110-1



COD: 152100-1



Inceand cu
€3252



MODEL		SL30	SL36
Fasonare 1 fir	otel 45 kg	30 mm	36 mm
	otel 65 kg	20 mm	26 mm
	otel 85 kg	18 mm	22 mm
Fasonare 2 fire	otel 45 kg	16 mm	18 mm
	otel 65 kg	14 mm	14 mm
	otel 85 kg	12 mm	12 mm
Putere motor		3 kW/400V	3 kW/400V
Greutate		275 kg	400 kg
COD		152100-1	152110-1
Pret lista		€3,567	€3,902
Pret Promotie		€3,252	€3,557

MASINA DE CONFECTIONAT ETRIERI ST16 Evo 230V | ST16 Evo 380V



COD: ST16TTF02 | ST16TTF01



Inceand cu
€2693



MODEL		ST16 Evo 230V	ST16 Evo 380V
Fasonare 1 fir	otel 65 kg	16 mm	16 mm
	otel 85 kg	14 mm	14 mm
	otel 65 kg	12 mm	12 mm
Fasonare 2 fire	otel 85 kg	10 mm	10 mm
	otel 65 kg	10 mm	10 mm
	otel 85 kg	8 mm	8 mm
Putere motor		1.5 kW/230V	1.5 kW/400V
Greutate		196 kg	196 kg
COD		ST16TTF02	ST16TTF01
Pret lista		3,151	2,934
Pret Promotie		2,892	2,693

MASINA DE INDREPTAT SI DEBITAT OTEL BETON IOM-12-RU



COD: IOM-12-RU

€23663
€25740



Masina de indreptat si debitat otel beton prezinta doua regimuri de lucru: manual si automat.

Mod Manual - se foloseste la prima incarcare cu otel beton sau pentru testare. Testarea sistemului hidraulic, tractiunea, taierea, masurarea si rotirea arborelui.

Mod Automat - prezinta tractiune si indreptare automata a sarmei din otelul beton si il poate debita cu numar si lungime programata.



Masina este formata din trei module:

1. Derulator pentru sustinerea colacului din sarma
2. Modul de indreptat si debitat
3. Suporti pentru vergele debitate IOM-10(12)-START (1+3buc.), IOM-12-RU 6 buc.

MASINA DE INDREPTAT SI DEBITAT OTEL BETON IOM-10(12)-START



COD: 101010



€12791
€15427

Stoc limitat!



MASINA DE INDREPTAT SI DEBITAT OTEL BETON	IOM-12-RU	IOM-10(12)-START
Diam. sarmei	Ø 6 mm ÷ Ø 12 mm	Ø3 ÷ Ø10(12) mm
Diam. ext. colac din sarma	< 1550 mm	< 1550 mm
Diam. int. colac din sarma	>790 mm	> 790 mm
Viteza de tractiune	1 m/sec	46 ÷ 60 m/min
Turatii arbore	1680 rot./min.	1580 rot./min.
Timp de taiere	0,006 min	0.0025 min
Putere de tractiune	9730 N	9730 N
Lungimea de taiere	0,1 m ÷ 99 m	0,1 m ÷ 99 m
Toleranta lungimii sarma	± 1 mm	± 5 mm
Numar de taieri / 1 ciclu	1 ÷ 9999	1 ÷ 9999
Putere motor	15 kW/380 V	11 kW/ 380 V
Greutate masina	880 kg	940 kg
Greutate totala cu module	1230 kg	1430 kg
COD	IOM-12-RU	101010

MASINA DE INDOIT SARMA AB 7 3D

COD: AB73D

€38083
€45985



MASINA DE INDOIT SARMA	AB 7 3D
Diametru max. indoire	7 mm
Viteza derulare	0 ÷ 100 m / min
Viteza fasonare	0 ÷ 340° / s
Timp taiere	0.25 sec
Nr. laturi / unghiuri programabile piesa	1 ÷ 100
Latura maxima indoita	500 mm
Unghi max. indoire	180°
Toleranta unghiuri de indoire	± 0,5°
Numarul programelor PC	200
Putere instalata	18 kW/380 V
Greutate	1400 kg.
Dimensiuni masina	2800x1600x2000 mm

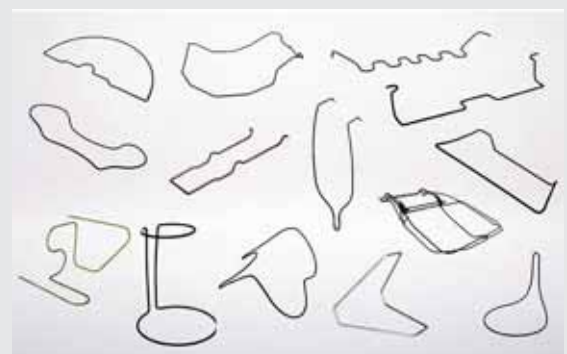

MASINA AUTOMATA DE CONFECTIONAT ETRIERI ABB-16 | ABB-12 | AB-10



Incepand cu
€49880

- ✓ Masina efectueaza automat rularea, indreptarea, indoirea in diferite unghiuri, taierea la dimensiunile programate, a otelului-beton, din bobina
- ✓ Indreptarea firului de beton se face prin sistemul de tambur rotativ si rolele de tragere



MODEL	ABB-16	ABB-12	AB-10
Diametrul max. de lucru	Ø 16 mm	Ø 12 mm	Ø 10 mm
Viteza derulare	0 ÷ 100 (0÷50 1/2) m / min	0 ÷ 105 m / min	0 ÷ 1 m / min
Viteza fasonare	0 ÷ 285 ° / s	0 ÷ 800 ° / s	0 ÷ 300 ° / s
Timp taiere	0.15(0,3 1/2) sec	0.25 sec	0.25 sec
Nr. max. indoiri per program	1 ÷ 200	1 ÷ 200	1 ÷ 200
Lungimea max. latura etrier	1500 mm	900 mm	900 mm
Lungimea min. la prima latura fasonata	150 mm	90 mm	50 mm
Unghi max. fasonare in sens orar/ antiorar	180°	180°	180°
Toleranta laturi fasonate	± 1 mm	± 1 mm	± 1 mm
Toleranta unghiuri fasonate	± 1 °	± 1 °	± 1 °
Numarul programelor PC.	100	200	200
Putere instalata	49 kW/ 380 V	16 kW/ 380 V	7,5 kW/ 380 V
Dimensiuni masinal(LxIxh)	5800 x 2500 x 1600 mm	4860 x 1340 x 2400 mm	2830 x 1370 x 2400 mm
Greutate	2800 kg	2400 kg.	1720 kg.
COD	KABB16	KABB12	KAB10
Pret lista	€93,481	€66,385	€61,557
Pret Promotie	€ 76,820	€ 53,757	€ 49,880

Compania ZMM "Stomana" JSC, fondată în 1945, este producătorul bulgar pentru echipamentele NIKMANN, specializat în mașini de prelucrare a lemnului de înaltă calitate. Gama de produse include diverse tipuri de mașini de prelucrare a lemnului, cum ar fi mașini combinate, mașini de rindeluit, mașini de găurit, fierăstraie, mașini de șlefuit, mașini de aplicat cant, sisteme de aspirare pentru rumeguș și multe altele.



Încă din 1996 PROMA produce și comercializează mașini-unelte pentru prelucrarea lemnului, adaptate perfect necesitatilor actuale, privind raportul calitate/preț, cuprinzând categorii precum semi-profesionale, profesionale și industriale.

PROMA-Group, cu distribuitori în peste 10 țări și experiența de peste 25 ani, se remarcă prin viziunea asupra dezvoltării durabile, trăsăturile caracteristice ale mașinilor produse și distribuite fiind construcția lor rigidă, stabilitatea, calitatea și eficiența.



FERVI Group este o companie de succes cu experiența de peste 40 de ani în producția și comercializarea de echipamente, scule și accesorii pentru prelucrarea lemnului. FERVİ Group deține 8 unități de producție plasate în Italia, Spania, Elveția, India și China, având un sortiment de peste 4300 produse, certificate CE și în conformitate cu normele și standardele UE.



PRELUCRARE LEMN

FIERASTRAU CIRCULAR DE FORMATIZAT S315-3200 | S315-2544

NIKMANN MASCHINEN



Incepand cu
€5808



MODEL	S315-3200	S315-2544
MODEL	S315-3200	S315-2544
Masa de formatizat	3200 x 350 mm	2544 x 350 mm
Lungime de taiere	3200 mm	2544 mm
Dimensiuni panza circulara	315 x 30 mm	
Taiere la 90°	102 mm	
Taiere la 45°	72 mm	
Putere motor	3,0 kW/400 V	
Greutate	480 kg	
COD	S315-3200	S315-2544
Pret lista	€8,340	€7,149
Pret promotie	€6,900	€5,808

FIERASTRAU CIRCULAR DE FORMATIZAT PKS-300F

COD: 25022000

PROMA



€5750
€6168

DOTARE STANDARD

- Sanie pe ghidaje din metal
- Reglarea adancimii de taiere
- Masa de lucru din fonta

Masa de formatizat	3200 x 370 mm
Cursa de lucru	3100 mm
Dimensiuni panza	300 x 30 mm
Taiere la 90°	80 mm
Taiere la 45°	55 mm
Dimensiune panza incizor	120 x 20 x (2,9 - 3,6) mm (24 z)
Turatie incizor	8000 rpm
Putere motor	4 kW/ 400V
Greutate	690 kg



FIERASTRAU CIRCULAR CU INCIZOR PKS-315F

COD: 25022001

PROMA



€2625
€2942

DOTARE STANDARD

- Sanie pe ghidaje din metal
- Reglarea adancimii de taiere
- Constructia rigida absoarbe vibratiile in timpul functionarii



Masa de formatizat	1550x1020 mm
Cursa de lucru	1680 mm
Dimensiuni panza	315 x 30 mm
Taiere la 90°	100 mm
Taiere la 45°	80 mm
Dimensiune panza incizor	90 x 20 x (3 - 3,5) mm (12 z)
Turatie incizor	5800 rpm
Putere motor	3,8 kW/400 V
Greutate	255 kg

FIERASTRAU CIRCULAR PKS-315SI

COD: 25000314

PROMA



Dimensiuni masa de lucru	800 x 550 mm
Masa suplimentara	800 x 550 mm
Dimensiuni panza	315 x 30 mm
Taiere la 90°	90 mm
Taiere la 45°	50 mm
Putere motor	2,5 kW/400 V
Greutate	55 kg

€580
€657

Livrare imediata din stoc



FIERASTRAU CIRCULAR PKS-315I

COD: 25022315

PROMA



Dimensiuni masa de lucru	800 x 550 mm.
Masa suplimentara	800 x 400 mm
Dimensiuni panza	315 x 30 mm
Taiere la 90°	90 mm
Taiere la 45°	50 mm
Putere motor	3 kW/400 V
Greutate	40 kg

€426
€505

Stoc limitat!



PRELUCRARE LEMN

FIERASTRAU CIRCULAR CBS-2400

COD: 5262400

Stoc limitat!

BELMASH®



€338
€458

Dimensiuni masa de lucru	800 x 550 mm
Dimensiuni cu masa suplimentara	1400 x 400 mm
Dimensiuni panza	280 mm
Taiere la 90°	103 mm
Taiere la 45°	70 mm
Putere motor	2,4 kW/400 V
Greutate	65 kg



FIERASTRAU CIRCULAR 0871

COD: 0871

FERVI



€550
€582

Diametru disc circular	305x3,2x30 40Z mm
Turatie disc circular	4500 rpm
Distanta de alunecare	215 mm
Debitare maxima	45°- 90°: 340x100 mm
	0 - 90°: 240x100 mm
Putere motor electric	2 kW / 230 V
Greutate	25 kg



FIERASTRAU VERTICAL CU BANDA PENTRU LEMN FC94/245

FERVI



€531
€598

COD: FC94/245

Diametru role	255 mm
Inaltime max. taiere	120 mm
Inclinare masa	0 ÷ 45°
Dimensiune masa	340 x 340 mm
Viteza de taiere	11-16 m/s
Putere motor	0,37 kW/230 V
Greutate	29 kg



FIERASTRAU VERTICAL CU BANDA PENTRU LEMN PP-500

COD: 25601500

PROMA



€1599
€1866

Diametru role	460 mm
Inaltime max. taiere	445 mm
Unghi inclinare	0-45°
Dimensiuni masa	500 x 600 mm
Viteza de taiere	6,6 m/s
Putere motor	2,2 kW/400 V
Greutate	210 kg



FIERASTRAU VERTICAL CU BANDA PENTRU LEMN BS 61

COD: BS61

DOTARE STANDARD



- ✓ roți cauciucate;
- ✓ masa de lucru inclinabilă;
- ✓ ghidaj din aluminiu pentru masa fixă;
- ✓ limitator longitudinal din aluminiu;
- ✓ stand suport;
- ✓ sistem de franare cu pedalier.

€3950
€4261



NIK MACHINEN

Diametru role	610 mm
Inaltime max. taiere	470 mm
Unghi inclinare	-15° ÷ +45°
Dimensiuni masa	650 x 800 mm
Viteza banda	28 m/s
Putere motor	4 kW/230 V
Greutate	410 kg



FERASTRAU PENTRU BUSTENI, GATER HBB 550

COD: HBB550

ACCESORII STANDARD

NIK MACHINEN



- ✓ Motor electric
- ✓ Sanie avans pentru lungimi de max. 4,6 m
- ✓ Sistem de racire si lubrefiere panza
- ✓ Debitaza esente de lemn uscat sau verde, atat busteni,

- ✓ cat si piese prismatice.
- ✓ Ideal pentru exploatarea intensiva pentru aplicatii agricole, forestiere, tamplarie etc

€3176
€3908

Diametru max. bustean	550 mm
Adancime max. debitare	220 mm
Lungime de taiere	3700 mm
Dimensiuni panza	3200 x 27 x 0,9 mm
Tip avans	manual
Putere motor	3,0 kW/400V
Greutate	355 kg



MASINA PENTRU FREZAT CU MASA DE FORMATIZAT T 1002 L

COD: T1002L

ACCESORII STANDARD

NIKMANN MACHINEN



- ✓ Ax frezor interschimbabil MK 4
- ✓ Ghidaj special
- ✓ Dispozitiv de protectie si presare
- ✓ Scule

€5556
€6839



Cursa ax	180 mm
Diametru ax	30 mm
Dimensiuni masa	1000 x 650 mm
Inclinare ax	0 ÷ 45°
Turatii ax	3000 ÷ 10000 rpm
Putere motor	3,2/4,0 kW/400 V
Greutate	450 kg
Putere motor	4 kW/ 400V
Greutate	446 kg

MASINA DE FREZAT LEMN TFS-1000/30

COD: 25005111

PROMA



Cursa ax	100 mm
Diametru ax	30 mm
Dimensiuni masa	1000 x 360 mm
Inclinare ax	-5° +45°
Turatii ax	1800 - 9000 rot/min
Putere motor	2,8 kW/400 V
Greutate	240 kg

€2485
€2807



MASINA DE FREZAT LEMN TFS-100/30

COD: 25005110

PROMA



Cursa ax	100 mm
Diametru ax	30 mm
Dimensiuni masa	640 x 710 mm
Inclinare ax	-5° +30°
Turatii ax	1800 ÷ 9000 rpm
Putere motor	2,8 kW/400 V
Greutate	201 kg

€1990
€2312



MASINA DE FREZAT LEMN 0559

COD: 0559

FERVI



Cursa ax	105 mm
Diametru ax	30 mm
Dimensiuni masa	600 x 400 mm
Turatii ax	1500 ÷ 6000 rpm
Putere motor	1,5 kW/230 V
Greutate	110 kg

Stoc limitat!

€1177
€1549



MASINA PENTRU GROSIME DMS 53

COD: DMS53

NIKMANN MACHINEN



Latime degrosare	530 mm
Inaltime degrosare min/max	3 - 300 mm
Lungime masa degrosare	950 mm
Adancime max. degrosare	8 mm
Viteza de avans	8 / 16 m/min
Diametru bloc taietor	125 mm
Putere motor	5,5 kW/400 V
Greutate	680 kg

€5768
€6196



MASINA PENTRU GROSIME DMS 41

COD: DMS41

NIKMANN MACHINEN



Latime degrosare	398 mm
Inaltime degrosare min/max	4 - 225 mm
Lungime masa degrosare	800 mm
Adancime max. degrosare	4 mm
Viteza de avans	6 / 12 m/min
Diametru bloc taietor	100 mm
Putere motor	3 kW/400 V
Greutate	425 kg

€3800
€4036



MASINA DE RINDELUIT SI DEGROSAT FS 41N

COD: FS41N

NIKMANN MACHINEN



Latime rindeluire	410 mm
Grosimea max. rindeluire	5 mm
Numar cutite	4 buc.
Putere motor	3,0 kW/400V
Greutate	450 kg

€3471
€4272



PRELUCRARE LEMN

MASINA DE RINDELUIT SI DEGROSAT HP-410N/400

COD: 25026012

PROMA



Latime rindeluire	450 mm
Grosimea max. rindeluire	5 mm
Numar de cutite	4 buc
Putere motor	3.5 kW/400V
Greutate	343 kg

€3299
€3618



MASINA DE RINDELUIT SI DEGROSAT HP-310/400

COD: 25000257

PROMA



Latime rindeluire	310 mm
Grosimea max. rindeluire	5 mm
Numar de cutite	3 buc.
Putere motor	2,2 kW/400V
Greutate	345 kg



Stoc limitat!

€1950
€2791



MASINA DE RINDELUIT SI DEGROSAT HP-309L/400

COD: 25000259

PROMA



Latime rindeluire	310 mm
Grosimea max. de rindeluire	3 mm
Numar de cutite	3 buc.
Putere motor	2,2 kW/400V
Greutate	179 kg

Stoc limitat!

€1591
€1783



MASINA DE RINDELUIT PT250/230V

COD: PT250/230V

CORMAK



Latime rindeluire	248 mm
Grosime max. rindeluire	3 mm
Numar cutite	3 buc.
Putere motor	2 kW/230 V
Greutate	150 kg

Stoc limitat!

€1299
€1578



MASINA DE RINDELUIT SI DEGROSAT HP-250-3/230 | HP-250-3/400

PROMA



Incepand cu
€1188

Model	HP-250-3/230	HP-250-3/400
Latime rindeluire	250 mm	250 mm
Grosimea max. rindeluire	5 mm	5 mm
Numar de cutite	3 buc.	3 buc.
Putere motor	2 kW/230 V	2 kW/400 V
Greutate	191 kg	148 kg
COD	25000069	25000070
Pret lista	€1,425	€1,331
Pret promotie	€1,271	€1,188

BEST SELLER

Stoc limitat!



MASINA DE MORTEZAT LEMN LBM 200

COD: LBM200

NIKMANN MASCHINEN



Diametru max. a sculei	20 mm
Dimensiuni masa	600 x 320 mm
Turatii	2840 rpm
Putere motor	2,2 kW/400 V
Greutate	180 kg

€2180
€2232



MASINA DE RINDELUIT COMBINATA 0686/200

COD: 0686/200

FERVI



Dimensiuni masa	737 x 210 mm
Numar cutite	2
Capacitate rindeluire	204 x 2 mm
Capacitate grosime	204 x 2 mm
Viteza arbore taiere	8000 rot/min
Putere motor electric	1,25 kW / 230V
Greutate	25 kg

€392
€562

Stoc limitat!



PRELUCRARE LEMN

MASINA DE MORTEZAT PDS-140

COD: 25029006

PROMA



Diametru max. a sculei	16 mm
Dimensiuni masa	500 x 210 mm
Turatii	2860 rpm
Putere motor	2,2 kW/400 V
Greutate	97 kg

€990
€1109

Stoc limitat!



MASINA PENTRU SLEFUIT ORIZONTALA LBS 3000

COD: LBS3000

NIKMANN



Dimensiuni masa	3000 x 820 mm
Cursa mesei mobile	600 mm
Lungime de slefuire	3000 mm
Putere motor	2,4/3,0 kW/400 V
Greutate	510 kg

€4978
€6127



MASINA PENTRU SLEFUIT CANTURI KSM 2600

COD: KSM2600

NIKMANN



Dimensiuni masa	750 x 300 mm
Dimensiuni banda slefuit	2600 x 150 mm
Cursa oscilatiei	20 mm
Viteza banda slefuit	20 m/sec.
Putere motor	3,0 kW/400 V
Greutate	180 kg

€2282
€2809



MASINA DE SLEFUIT BP-152P

COD: 25702153

PROMA



Dimensiune banda	152 x 2010 mm
Viteza banda	780 m/min
Unghiul de fixare	0-45°
Putere motor	1,1 kW/230V
Greutate	72 kg
Greutate	180 kg

€681
€782



MASINA STATIONARA PENTRU APLICAT CANT KZM 6RTF

COD: KZM6RTF

NIKMANN



€24450
€27631

- ✓ Unitate de pre-frezare
- ✓ Unitate incalzire panou PAL
- ✓ Unitate rezervor adeziv
- ✓ Unitate presare cant PVC/ABC
- ✓ Unitate de taiere colturi cant
- ✓ Unitate role taietoare
- ✓ Unitate Enitati rotunjire colturi blat
- ✓ Unitate rindeluire surplus material
- ✓ Unitate inlaturare surplus adeziv
- ✓ Unitate polisare

Grosime cant (PVC)	0,40 - 3,00 mm
Grosime min / max. panou	10 - 45 mm
Lungime min piesa prelucrat	100 mm
Viteza de avans	10 m/min
Putere totala	6,7 kW/400 V
Greutate	1170 kg



MASINA STATIONARA PENTRU APLICAT CANT PE SUPRAFETE CURBE KZM 7 | KZM 9



Inceand cu
€2589

MODEL	KZM9	KZM7
Grosime cant (PVC)	0,40 - 3,00 mm	0,40 - 3,00 mm
Grosime min / max. panou	10 - 50 mm	10 - 50 mm
Diimensiuni min piesa	-	85 x 200 mm
Putere totala	2,75 kW	0,8 kW
Greutate	300 kg	50 kg
COD	KZM9	KZM7
Pret lista	€ 6,001	€ 3,186
Pret promotie	€ 4,876	€ 2,589

- ✓ Ideale pentru prelucrarea canturilor de ABS, PVC, cant melaminat si furnir
- ✓ Prevazute cu rola speciala pentru aplicarea adezivului
- ✓ Lucreaza automat cu ajutorul unei pedale actionata pneumatic

NIKMANN

COD: KZM7



COD: KZM9



PRELUCRARE LEMN

STRUNG PENTRU LEMN CL 1201 A

COD: CL1201A



€5552
€6833

- ✓ Suport dalta 254 mm
- ✓ Varf de centrare
- ✓ Flansa 254 mm
- ✓ Stand cu suport pentru 4 dalti
- ✓ Cutite copiere 16 x 16 mm (2 buc)
- ✓ Motor de avans
- ✓ Protectie rumegus
- ✓ Scule

Acest strung lemn este dotat cu avans automat la copiere ce creste productivitatea in exploatare

Distanta dintre varfuri	1270 mm
Diametru de strunjire peste batiu	610 mm
Turatii ax	375 - 3250 rpm
Con pinola	MK III
Cursa pinolei	140 mm
Putere motor	1,1 kW/230V
Greutate aproximativa	530 kg



STRUNG PENTRU LEMN CL 1201

COD: CL1201



€4514
€5556

- ✓ Suport dalta 254 mm
- ✓ Varf de centrare
- ✓ Flansa 254 mm
- ✓ Stand cu suport pentru 4 dalti
- ✓ Cutite copiere 16 x 16 mm (2 buc)
- ✓ Protectie rumegus
- ✓ Scule

Distanta dintre varfuri	1270 mm
Diametru de strunjire peste batiu	610 mm
Turatii ax	375 - 3250 rpm
Con pinola	MK III
Cursa pinolei	140 mm
Putere motor	1,1 kW/230V
Greutate aproximativa	560 kg



STRUNG PENTRU LEMN DSL-1100V

COD: 25406144



€735
€845

Stoc limitat!

Distanta dintre varfuri	1100 mm
Diam. strunjire peste batiu	370 mm
Turatii ax	500-2000 rot/min
Con pinola	Mk II
Numar de viteze	10
Putere motor	0,55 kW/230 V
Greutate	92 kg



STRUNG PENTRU LEMN DSO-1000

COD: 25406130



€246
€291

Livrare imediata din stoc

Distanta dintre varfuri	1000 mm
Diam. strunjire peste batiu	350 mm
Turatii ax	850-2510 rot/min
Numar de viteze	4
Putere motor	0,4 kW/230 V
Greutate	35 kg



DISPOZITIV DE COPIERE SKZ-93

COD: 25406145



€182
€215

Stoc limitat!

Lungimea max. piesa	1100 mm
Cursa maxima	35 mm
Inaltimea centrului	150-210 mm
Dimensiuni	1230x380x330 mm
Greutate	18 kg



MASINA PENTRU GAURIT MULTIPLU BM 21E

COD: BM21E



€4136
€5090

Adancime max. gaurire	70 mm
Numar axuri	21 buc.
Dimensiuni masa	880 x 425 mm
Turatii	2850 rpm
Putere motor	1,1 kW/400 V
Greutate	275 kg



MASINA COMBINATA UNIVERSALA K5-41



COD: K5-41



✓ Aceasta masina lemn este dotata cu o masa de formatizat cu lungimea de 1500 mm.

Unitati de lucru:

- Rindeluire
- Degrosare
- Freza
- Ferastrau circular

Dimneune masa rindeluire	1800 x 410 mm
Putere motor rindeluire	3.0 kW
Dimensiuni masa degrosare	700 x 406 mm
Diametru disc - max /min	Ø 315/ Ø 250 mm
Putere motor circular	2,2 kW
Diametru ax freza lemn	Ø 30 mm
Dimensiunile masa lucru	1250 x 450 mm
Putere motor freza	2,2 kW
Greutate	840 kg

€7736
€9522



MASINA COMBINATA UNIVERSALA K5-32



COD: K5-32



✓ Aceasta masina lemn este dotata cu o masa de formatizat cu lungimea de 1500 mm.

Unitati de lucru:

- Rindeluire
- Degrosare
- Freza
- Ferastrau circular

Dimneune masa rindeluire	1500 x 320 mm
Putere motor rindeluire	2.2 kW
Dimensiuni masa degrosare	600 x 316 mm
Diametru disc - max /min	Ø 315/ Ø 250 mm
Putere motor circular	2.2 kW
Diametru ax freza lemn	Ø 30 mm
Dimensiunile masa lucru	1250 x 450 mm
Putere motor freza	2.2 kW
Greutate	650 kg

€7141
€8789



MASINA COMBINATA CIRCULAR DE FORMATIZAT SI FREZAT SF 2



COD: SF2-2300



✓ Aceasta masina lemn este dotata cu o masa de formatizat cu lungimea de 2300 mm.

Unitati de lucru:

- Freza
- Ferastrau circular

Diametru disc ferastrau	Ø 315/ Ø 250
Lungime max. taiere	2150 mm
Adancime max. taiere	102 / 72 mm
Turatii ferastrau	4000 rpm
Putere motor ferastrau	3.0 kW
Diametru ax freza	Ø 30 mm
Potere motor freza (2 viteze)	3.2/4.2 kW
Greutate	790 kg
Turatii freza	pana la 8000 rpm

€7530
€9268



MASINA DE INDREPTAT SI PROFILAT PE PATRU FETE VS 20N1



COD: VS20N1



✓ Constructia robusta garanteaza lucrul fara vibratii
✓ Poate fi utilizata atat pentru prelucrarea elementelor individuale, precum si in serie

Unitati de lucru:

- 4 blocuri taietoare
- Motor de avans in doua trepte
- 2 trepte viteza de avans

Latime rindeluire min/max	25 - 180 mm
Latime rindeluire min/max	10 - 105 mm
Lungime masa alimentare	1700 mm
Numar axuri rindeluire	4 axuri
Viteza de avans	6 + 12 m/min.
Putere totala racordare	17,1 kW/400V
Greutate aproximativa	950 kg

€11756
€14469



EXHAUSTOR (ASPIRATOR RUMEGUS) SAM 2



COD: SAM2



✓ Construcția robustă din tablă de oțel asigură o încărcare electrostatică mai mică în comparație cu cele construite din plastic

Accesorii standard:

- Sac filtrant (2 buc)
- Sac colector (2 buc)
- Rotile pentru deplasare
- Manual utilizare

Debit aer max	4500 m ³ /h
Suprafața de filtrare	6,0 m ²
Vacuum	2000 Pa
Diametru racord aspirare	3 x 120 mm
Putere motor	2,2 kW (3,0 CP)
Tensiune	400 V
Greutate	100 kg

€1592
€1684



EXHAUSTOR (ASPIRATOR RUMEGUS) OP-4700

COD: 25004700



Volum sac colector	226 l
Capacitate aspiratie	4560 m ³ /h
Putere motor	5.25 kW/400 V
Greutate	100 kg

€999
€1119



EXHAUSTOR (ASPIRATOR RUMEGUS) 0496

COD: 0496



Volum sac colector	300 l
Capacitate aspiratie	3900 m ³ /h
Putere motor	2,2 W/230 V
Greutate	50 kg

€509
€738



EXHAUSTOR (ASPIRATOR RUMEGUS) OP-2200

COD: 25003003



BEST SELLER

Volum sac colector	300 l
Capacitate aspiratie	6000 m ³ /h
Putere motor	2,2 W/400 V
Greutate	59 kg

€475
€483



Livrare imediata din stoc

EXHAUSTOR (ASPIRATOR RUMEGUS) 0759

COD: 0759



BEST DEAL

Capacitate aspiratie	2500 m ³ /ora
Putere motor electric	1,5 kW/230 V
Viteza motorului	2950 rpm
Greutate	41 kg

€368
€627



Stoc limitat!

EXHAUSTOR (ASPIRATOR RUMEGUS) OP-1500 | OP-750



Incepand cu
€275

COD: 25003002



COD: 25002301



Model	OP-1500	OP-750
Volum sac colector	150 l	70 l
Capacitate aspiratie	3000 m ³ /h	1020 m ³ /h
Putere motor	1,5 kW/230 V	0,75 kW/230 V
Greutate	47 kg	27 kg
COD	25003002	25002301
Pret lista	€487	€289
Pret promotie	€395	€275

Livrare imediata din stoc



COD: 25750026

€171
€214



OP-1500	Filtru
Densitate filtru	1 micron
Greutate	9/12 kg

FERVI

FERVI Group este o companie de succes cu experienta de peste 40 de ani in productia si comercializarea de echipamente, scule si accesorii. FERVI Group detine 8 unitati de productie plasate in Italia, Spania, Elvetia India si China, avand un sortiment de peste 4300 produse.

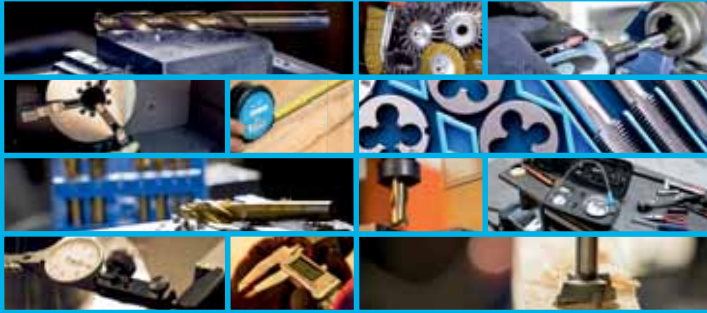

PROMA

Raportul optim între preț și performanță, împreună cu calitatea înaltă, predestinează sculele și accesorii PROMA atât pentru ateliere, cât și pentru o întreagă gamă de utilizatori profesioniști - pentru departamentele de reparații și întreținere ale companiilor, pentru operațiuni de prelucrare a metalelor și a lemnului.



CB



CB SABBIATRICI este lider in producția și distribuția de mașini/cabine de sablat cu jet aer și cabine de sablat cu alicie și accesorii pentru sablat. Toate mașinile se produc în fabrica din Oggiono (LC), sub prevederile directivei UE, fiind comercializate în Europa, Africa de Nord, Asia și Orientul Mijlociu.



Prezent pe piață din 1948, BISON este unul dintre liderii mondiali în producția de scule profesionale pentru prelucrare. Produsele marca BISON, sunt recunoscute la nivel mondial pentru cel mai înalt standard de proiectare, producție, durabilitate, calitate și precizie.



VOGEL

GERMANY

Din 1949, VOGEL Germany GmbH & Co. KG este unul dintre liderii producători de instrumente de măsurare de precizie și instrumente de testare. Compania VOGEL și-a propus să domine provocările pieței, respectiv să ofere standarde de calitate mai ridicate pentru produse și servicii. Aceasta este o componentă fermă a politicilor VOGEL privind calitatea.



Link

INNOVATE YOUR INDUSTRY

Link Gruppo S.p.A. produce și distribuie macarale, scule, instrumente de măsurare, accesorii și bunuri pentru toate tipurile de prelucrări mecanice. Link Gruppo S.p.A. lucrează în conformitate cu procedurile Lean Six Sigma pentru o îmbunătățire continuă a proceselor, fiind și certificată UNI EN ISO 9001:2015.



ACCESORII SI CONSUMABILE

UNIVERSAL AUTOCENTRANT CU 3+3 BACURI M049A/250 | M049A/200 | M049A/160 | M049A/125 | M049A/100 | M049A/080

FERVI

Inceand cu
€127



MODEL	M049A/250	M049A/200	M049A/160	M049A/125	M049A/100	M049A/080
Diametru	250 mm	200 mm	160 mm	125 mm	100 mm	80 mm
H	80 mm	75 mm	65 mm	58 mm	55 mm	50 mm
z-d	3-M12 mm	3-M10 mm	3-M8 mm	3-M8 mm	3-M8 mm	3-M6 mm
COD	M049A/250	M049A/200	M049A/160	M049A/125	M049A/100	M049A/080
Pret lista	€397	€349	€275	€169	€162	€144
Pret promotie	€349	€308	€242	€149	€143	€127



UNIVERSAL AUTOCENTRANT CU 3 BACURI REVERSIBILE M005A/320 | M005A/250

FERVI

Inceand cu
€352



MODEL	M005A/320	M005A/250
Diametru	320 mm	250 mm
H	95 mm	80 mm
z-d	3-M16 mm	3-M12 mm
COD	M005A/320	M005A/250
Pret lista	€725	€400
Pret Promotie	€645	€352



UNIVERSAL AUTOCENTRANT CU 4+4 BACURI M076A/200

COD: M076A/200

FERVI



Diametru	200 mm
H	75 mm
z-d	3-M10 mm

€492
€553



UNIVERSAL AUTOCENTRANT CU 4+4 BACURI M449A/200 | M449A/160 | M449A/125 | M449A/080

FERVI

Inceand cu
€149



MODEL	M449A/200	M449A/160	M449A/125	M449A/080
Diametru	200 mm	160 mm	125 mm	80 mm
H	75 mm	65 mm	58 mm	50 mm
z-d	3-M10 mm	3-M8 mm	3-M8 mm	3-M6 mm
COD	M449A/200	M449A/160	M449A/125	M449A/080
Pret lista	€427	€274	€202	€170
Pret Promotie	€376	€241	€178	€149



VARF ROTATIV MT 5 C046/5 | C046/4

FERVI

Inceand cu
€54.14



MODEL	C046/5	C046/4
Prindere	MT 5	MT 4
Centru	60°	60°
Coloana	80 mm	63 mm
Lungime	256 mm	208 mm
COD	C046/5	C046/4
Pret lista	€69.9	€61.52
Pret Promotie	€61.51	€54.14

VARF ROTATIV MT4 C055/4

COD: C055/4

FERVI



Prindere	MT4
Diametru	66 ÷ 200 mm
Lungime	290 mm

€239
€276



DORN FREZARE 2/3B40 | 2/1B40

FERVI



Inceand cu
€79.92



- TURATII 2000 RPM
- DIN 2080



MODEL	2/3B40	2/1B40
Con	ISO 40	ISO 40
Prindere	CM3	CM1
Diametru	40 mm	25 mm
Lungime	64 mm	15 mm
COD	2/3B40	2/1B40
Pret lista	€119	€127
Pret Promotie	€102	€79.92

Stoc limitat!

Stoc limitat!

SET DISPOZITIVE DE FIXARE K001/18 | K001/16 | K001/14 | K001/12

FERVI

Inceand cu
€79.50



Stoc limitat!



Stoc limitat!

ACCESORII SI CONSUMABILE

SET BUCSE ELASTICE P032/18P | P032/7P

FERVI



Incepad cu
€113

GARANTIE 24 Luni
ASISTENTA DE LA DISTANTA

MODEL	P032/18P	P032/7P
Dimensiuni	3-4-5-6-7-8-9-10-11-12-13-14-15-16-17-18-19-20 mm	4-6-8-10-12-16-20 mm
Greutate	3 kg	1,1 kg
COD	P032/18P	P032/7P
Pret lista	211	128
Pret promotie	€ 183	€ 113

MANDRINA RAPIDA M060/3

COD: M060/3

FERVI



Prindere	M3-12
Lungimea ax	228 - 190 - Ø 46 mm
Greutate	3,2 kg

€172
€288

Stoc limitat!

GARANTIE 24 Luni
ASISTENTA DE LA DISTANTA

MANDRINA RAPIDA 1-20/B22 | 1-16/B18 | 1-13/B16

FERVI



Incepad cu
€54.61

GARANTIE 24 Luni
ASISTENTA DE LA DISTANTA

MODEL	1-20/B22	1-16/B18	1-13/B16
Capacitate	1 ÷ 20 mm	1 ÷ 16 mm	1 ÷ 13 mm
Prindere	DIN B 22	DIN B 18	DIN B 16
Lungime	119 mm	102 mm	91 mm
Coloana	Ø 59 mm	Ø 54 mm	Ø 49 mm
COD	M051/20	M051/16	M051/13
Pret lista	€86.71	€73.99	€62.06
Pret Promotie	€ 76.30	€ 64.98	€ 54.61

Livrare imediata din stoc

MANDRINA ELASTICA 3/B/40

COD: 3/B/40

FERVI



Prindere	ER32
A	3/20 mm
D	50 mm
L	65 mm
F	M 16

€78.99
€90.62

Livrare imediata din stoc

GARANTIE 24 Luni
ASISTENTA DE LA DISTANTA

MANDRINA ELASTICA 3/CM4

COD: 3/CM4

FERVI



€59.4
€67.65

GARANTIE 24 Luni
ASISTENTA DE LA DISTANTA

Prindere	ER32
D	50 mm
L	166 mm
L1	58 mm
F	M 16

CAP DIVIZOR CU PAPUSA SI DISCURI D006/128

COD: D006/128

FERVI



Diametru ax	20 mm
Con	MC-MT III
Raport	1:40
Greutate	30 kg

€688
€995

Stoc limitat!

BEST DEAL

GARANTIE 24 Luni
TRANSPORT GRATUIT
ASISTENTA DE LA DISTANTA

MASA CU ROLE PS-604

COD: 25000604

PROMA



Inaltime reglabila	650 - 1020 mm
Lungime masa	1000 mm
Diametru cilindru	60 mm
Latime cilindru	360 mm
Capacitate ridicare	400 kg
Greutate	30 kg

€199
€213

Livrare imediata din stoc

GARANTIE 24 Luni
ASISTENTA DE LA DISTANTA

MASA ROTATIVA T002/200

COD: T002/200

FERVI



Diametru	200 mm
Con	MT 3
Canale	4/12 N° / mm
Sarcina orizontala	150 kg
Sarcina verticala	75 kg
Greutate	30,5 kg

€774
€860

GARANTIE 24 Luni
TRANSPORT GRATUIT
ASISTENTA DE LA DISTANTA

MASA ROTATIVA OS-160

COD: 25000160

PROMA



Utilizare orizontala	da
Rotire	360°
Con	II
Canal	4x10 mm
Inaltimea	90 mm
Greutatea	23 kg

€320
€643

Stoc limitat!

BEST DEAL

GARANTIE 24 Luni
TRANSPORT GRATUIT
ASISTENTA DE LA DISTANTA

MASA CU DEPLASARE IN CRUCE T008

COD: T008

FERVI



Dimensiuni masa	475 x 153 mm
Cursa	120 x 325 mm
Dimensiuni baza	200 x 270 mm
Distanta intre canale	75 mm
Canal in masa	16 mm
Greutate	23 kg

€272
€309

GARANTIE 24 Luni
ASISTENTA DE LA DISTANTA

MASA CU DEPLASARE IN CRUCE G-5757

COD: 25005757

PROMA



Dimensiuni masa	305 x 140 mm
Cursa longitudinala	203 mm
Cursa transversala	125 mm
Canal T	12,7 mm
Pasul intre canalele T	115 mm
Greutate	17 kg

€143
€172

Stoc limitat!

GARANTIE 24 Luni
ASISTENTA DE LA DISTANTA

MENGINA ROTATIVA VS-125

COD: 25002125

PROMA



Dimensiuni falci	135 mm
Deschidere	125 mm
Greutate	16 kg

€101
€140

Livrare imediata din stoc

GARANTIE 24 Luni
ASISTENTA DE LA DISTANTA

MENGINA ROTATIVA M023/200 | M023/160 | M023/125 | M023/100

FERVI

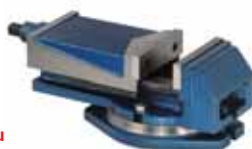

Incepad cu
€136

Stoc limitat!

GARANTIE 24 Luni
TRANSPORT GRATUIT
ASISTENTA DE LA DISTANTA

GARANTIE 24 Luni
ASISTENTA DE LA DISTANTA

BEST SELLER

MODEL	M023/200	M023/160	M023/125	M023/100
Latime falci	200x61 mm	160x50 mm	125x40 mm	100x35 mm
Deschidere	160 mm	125 mm	100 mm	80 mm
Canal T	18 mm	18 mm	14 mm	14 mm
Greutate	47 kg	30 kg	15 kg	11 kg
COD	M023/200	M023/160	M023/125	M023/100
Pret lista	€425	€301	€213	€156
Pret Promotie	€ 367	€ 238	€ 185	€ 136

ACCESORII SI CONSUMABILE

MENGHINA ROTATIVA M024/250 | M024/160 | M024/136

FERVI



Inceand cu
€148

MODEL	M024/250	M024/160	M024/136
Falci	250 x 45 mm	160 x 45 mm	136 x 32 mm
Deschidere	320 mm	180 mm	170 mm
Canal T	18 mm	14 mm	14 mm
Greutate	50 kg	23 kg	14 kg
COD	M024/250	M024/160	M024/136
Pret lista	€470	€226	€168
Pret Promotie	€395	€199	€148



MENGHINA ROTATIVA 0036/150G

FERVI



Inceand cu
€83.32



MODEL	0036/150G	0036/125G	0036/150	0036/125
Dimensiuni falci	150 mm	125 mm	150 mm	125 mm
Deschidere	180 mm	124 mm	180 mm	138 mm
Greutate	22 kg	11 kg	19 kg	9.5 kg
COD	0036/150G	0036/125G	0036/150	0036/125
Pret lista	€343	€186	€311	€166
Pret Promotie	€232	€140	€253	€83.32

Stoc limitat!

Livrare imediata din stoc

Stoc limitat!

Livrare imediata din stoc

BEST SELLER

MENGHINA ROTATIVA S0-160

COD: 25042009

PROMA



Dimensiuni falci	160 mm
Inaltime falci	52 mm
Deschidere	120 mm
Greutate	28 kg

€172
€207



MENGHINA ROTATIVA SWT-125

COD: 25300102

PROMA



Dimensiuni falci	125 x 44 mm
Deschidere	120 mm
Greutate	26 kg

€420
€497



MENGHINA ROTATIVA SWT-100

COD: 25300101

PROMA



Dimensiuni falci	105 x 40 mm
Deschidere	105 mm
Greutate	23 kg

€386
€457

Livrare imediata din stoc



MENGHINA ROTATIVA SI INCLINABILA M530/160 | M530/125 | M530/100

FERVI



Inceand cu
€226

MODEL	M530/160	M530/125	M530/100
Latime falci	160 x 50 mm	125 x 40 mm	100 x 32 mm
Deschidere	125 mm	100 mm	90 mm
Dimensiuni generale	443 x 270 x 194 mm	360 x 206 x 165 mm	325 x 180 x 150 mm
Greutate	35 kg	24 kg	15 kg
COD	M530/160	M530/125	M530/100
Pret lista	€387	€267	€257
Pret Promotie	€341	€235	€226



MENGHINA AUTOCENTRANTA 6531-160

COD: 326531070600

Stoc limitat!

BISON



Dimensiuni falci	160 x 50h mm
Fora prindere	4500 daN
Deschidere max falci	125 mm
Greutate	33.5 kg

€379
€1188



MENGHINA DE PRECIZIE M011/150/210

COD: M011/150/210

FERVI



Dimensiuni falci	150 x 60h mm
Precizie	0,02 mm
Greutate	36 kg

€1054
€1171



MENGHINA DE PRECIZIE M028/150/400

COD: M028/150/400

Stoc limitat!

FERVI



Dimensiuni falci	150 x 50 mm
Deschidere max falci	400 mm
Greutate	34 kg

€840
€1150



MENGHINA DE PRECIZIE SVA-160

COD: 25016160

PROMA



Latime falca	160 mm
Inaltime falca	45 mm
Deschidere max	200 mm
Inaltime menghina	122 mm
Greutate	25 kg

€217
€262



MENGHINA DE PRECIZIE M027/200 | M027/140 | M027/100

FERVI



Inceand cu
€113



MODEL	M027/200	M027/140	M027/100
Latime falci	200 x 60 mm	140 x 44 mm	100 x 44 mm
Deschidere	200 mm	140 mm	110 mm
Dimensiunea bazei	480 x 295 mm	375x 230 mm	290 x 170 mm
Greutate	25 kg	12 kg	8,5 kg
COD	M027/200	M027/140	M027/100
Pret lista	€326	€222	€144
Pret Promotie	€287	€195	€113

Stoc limitat!

ACCESORII SI CONSUMABILE

MENGHINA DE PRECIZIE M034/120

COD: M034/120



Latime falci	120 x 40 mm
Deschidere	120 mm
Greutate	7 kg

€246
~~€312~~

Stoc limitat!



MENGHINA DE PRECIZIE M012/100 | M012/080



Incepad cu
€114



MODEL	M012/100	M012/080
Latime falci	100 x 245 x 90h mm	73 x 190 x 67h mm
Deschidere	125 mm	110 mm
Precizie	0,005 mm	0,005 mm
COD	M012/100	M012/080
Pret lista	€233	€130
Pret Promotie	€205	€114

MENGHINA DE BANC 0174/150 | 0174/125



MODEL	0174/150	0174/125
Latime falci	150 x 22 mm	125 x 22 mm
Deschidere	150 mm	130 mm
Greutate	10 kg	7,7 kg
COD	0174/150	0174/125
Pret lista	€94.88	€74.51
Pret Promotie	€83.49	€64.93

Incepad cu
€64.93

Stoc limitat!



MENGHINA DE BANC M001/150

COD: M001/150



Latime falci	150 mm
Deschidere max falci	120 - 140 mm
Greutate	7,5 kg

€82.82
~~€94.11~~



MENGHINA CU REGLARE IN CRUCE 0188/150 | 0188/125 | 0188/100



Incepad cu
€63.19



MODEL	0188/150	0188/125	0188/100
Falci	150 x 40 mm	125 x 40 mm	100 x 25 mm
Deschidere	145 mm	110 mm	90 mm
Dimensiuni baza	280 x 170 mm	255 x 160 mm	240 x 140 mm
Cursa longitudinala	160 mm	170 mm	130 mm
Cursa transversala	180 mm	130 mm	110 mm
COD	0188/150	0188/125	0188/100
Pret lista	€132	€107	€71.81
Pret Promotie	€116	€94.01	€63.19

MENGHINA CU REGLARE IN CRUCE KS-125P

COD: 25300104



Latime falca	125 mm
Inaltime falca	50 mm
Deschidere max	125 mm
Greutate	18 kg

€156
~~€185~~



MENGHINA 90 GRADE 0205/120

COD: 0205/120

Livrare imediata din stoc



€69.78
~~€86.03~~



Capacitate	110 mm + 110 mm
Inaltime falca	60 mm
Greutate	10,39 kg

MENGHINA 90 GRADE 0205

COD: 0205

Livrare imediata din stoc



€19.6
~~€22.7~~



Capacitate	70 + 70 mm
Inaltime lucru	35 mm
Greutate	0.84 kg

MENGHINA 90 GRADE 60/110

COD: 25002300

Livrare imediata din stoc



Latime falca	133 mm
Inaltime falca	60 mm
Deschidere max	110 mm
Greutate	12 kg

€58.86
~~€69.7~~



DISPOZITIV DE RACIRE PCH-2

COD: 25000033

Livrare imediata din stoc



€252
~~€299~~



Volum rezervor lichid	27 l
Putere motor	40 W / 230 V
Inaltime max. de pompare	3 m
Debit maxim	12 l/min
Alimentare pompa	230 V
Dimensiuni	500 x 300 x 370 mm
Greutate	19 kg

NICOVALA OTEL 0157/50

COD: 0157/50



Material otel	C45
Toleranta	+/-5%
Greutate	50 kg

€352
~~€400~~



FURTUN FLEXIBIL SISTEM DE RACIRE F-T201 | F-T200



Incepad cu
€11.52

Livrare imediata din stoc



MODEL	F-T201	F-T200
Diametru interior tub flexibil	12 mm - 1/2"	Ø 6 mm - 1/4"
Lungime totala ansablu	320 mm	330 mm
Duze	Ø 9.5 mm, 12.5 mm, 6 mm - 1 buc	Ø 1.5 mm - 1 buc, Ø 3 mm - 1 buc, 7 mm - 1 buc
Racorduri	3/8" - buc	1/8" - 1 buc, 1/4" - 1 buc
COD	T201	T200
Pret lista	€15.94	€13.41
Pret Promotie	€13.79	€11.52

ACCESORII SI CONSUMABILE

LAMPA LED MASINI-UNELTE 0532A/230V | 0532A | 0538A

FERVI



Incepand cu
€107



MODEL	0532A/230V	0532A	0538A
Tensiune alimentare	13W 230 V	13W 24 V	7W 24 V
Flux lumina	1800 lm	1800 lm	700 lm
Temperatura lumina	6500 K	6500 K	6500 K
Numar leduri	9	9	7
Inaltime	900 mm	890 mm	650 mm
Grad protectie	IP65	IP65	IP44
COD	0532A/230V	0532A	0538A
Pret lista	€183	€169	€122
Pret Promotie	€122	€149	€107

Stoc limitat!

LAMPA HALOGEN MASINI-UNELTE FARA TRANSFORMATOR 0537

LAMPA LED MASINI-UNELTE 0371

LAMPA HALOGEN MASINI-UNELTE FARA TRANSFORMATOR 0531

Livrare imediata
din stoc

FERVI



€53.69
~~€74.18~~



0537	MODEL	0371
50W 24 V	Tensiune alimentare	10W 24 V
-	Flux lumina	1200 lm
-	Temperatura lumina	6500 K
-	Numar leduri	5
100 mm	Inaltime	110 mm
IP44	Grad protectie	IP65

€115
~~€131~~



COD: 0531

FERVI



€59.33
~~€81.99~~

Tensiune alimentare	50W 24 V
Numar articulatii	1
Diametru lentila	125 mm
Inaltime	110 mm
Grad protectie	IP65

Livrare imediata
din stoc



LAMPA LED MASINI-UNELTE 0536A

LAMPA LED CU LENTILE 0536

LAMPA CU BRAT FLEXIBIL 0343

COD: 0536A

FERVI



€109
~~€124~~



Tensiune alimentare	5W 24 V
Flux lumina	500 lm
Temperatura lumina	6400K
Numar articulatii	1
Inaltime	600 mm
Grad protectie	IP42

COD: 0536

FERVI



€69.86
~~€79.38~~



Tensiune alimentare	230 V / 12 V 25 W
Greutate	1,15 kg

COD: 0343

FERVI



€19.54
~~€22.2~~



Alimentare	230 V
Bec (neinclus)	40 W, E27
Raza	800 mm
Capacitate prindere	35 mm
Grad protectie	IP20
Greutate	0,99 kg

BANC DE LUCRU B009/B1

BANC DE LUCRU B009/A1

BANC DE LUCRU PLIABIL B019

COD: B009/B1

FERVI



€487
~~€548~~



Dimensiuni	1200 x 600 x 865h mm
Grosime su-prafata lucru	36 mm
Numar sertare/dulap	3 sertare si 1 dulap
Greutate	64,5 kg

COD: B009/A1

FERVI



€477
~~€537~~



Dimensiuni banc	1200 x 600 x 865h mm
Grosime picioare	2,0 mm
Grosime PAL	36 mm
Sertare	3 buc.
Capacitate	350 kg
Greutate	62 kg

COD: B019

FERVI



€338
~~€560~~

Stoc limitat!



Dimensiuni blat masa	1195 x 648 x 41 mm
Capacitate max. de incarcare	225 kg
Dimensiuni totale	1420 x 705 x 170 mm
Greutate	47 kg

BANC TAMPLARIE PTH-2100NB

SUPORT POLIZOR 0555

MANUSI DE SCHIMB PT MASINI DE SABLAT P/1

COD: 25069004

PROMA



€594
~~€682~~



Dimensiunile bancului	2060 x 815 x 95 mm
Inaltime lucru	815 mm
Material lemn masiv fag	
Greutate	68 kg

COD: 0555

FERVI



€91.89
~~€106~~



Greutate	14 kg
Inaltime	750 mm

COD: P/1

CB

Stoc limitat!



€94.95
~~€139~~



Manusi de schimb pentru masini de sablat PAL

MANUSI DE SCHIMB PT MASINI DE SABLAT 0575/29

MANUSI DE SCHIMB PT MASINI DE SABLAT 0580/21

PISTOL PULVERIZATOR PENTRU MASINI DE SABLAT P5

COD: 0575/29

FERVI



€26.59
~~€30.59~~



Manusi de schimb pentru masini de sablat tip:	0575
	0580
	0878

COD: 0580/21

FERVI



€13.98
~~€19.39~~



Lungime	450 mm
Diametru	145 mm

COD: P5

CB

Stoc limitat!



€114
~~€161~~



Pistol pulverizator pentru masini de sablat

ACCESORII SI CONSUMABILE

PISTOL PULVERIZATOR PENTRU MASINI DE SABLAT 0687/041

COD: 0687/041



Pistol pulverizator pentru masini de sablat

€91.62
€104



ASPIRATOR PENTRU MASINA DE SABLAT SA01/A

COD: SA01/A



Rata	5 micron
Permeabilitate	185 l/(m ² s)
Conexiune	Ø 55 mm
Dimensiuni Ø	290 X 730 mm
Greutate	10,38 kg

€300
€341

Stoc limitat!



ASPIRATOR INDUSTRIAL A030/60A

COD: A030/60A



Putere	1400W
Aspiratie aer	46L/s
Capacitate	60L
Alimentare	220V/50Hz
Greutate	13 kg

€147
€214

Stoc limitat!



DISPOZITIV DE MORTEZAT 0749/M

COD: 0749/M



Mandrina	Ø 16 mm
Dimensiuni masa	370 x 150 mm
Cursa verticala	0 - 80 mm
Cursa laterala	0 - 140 mm
Distanta dintre gauri	3 x 165 mm
Greutate neta	26 kg

€289
€469

Stoc limitat!



DISPOZITIV DE MORTEZAT HP-310

COD: 25000256

Stoc limitat!



Deplasearea fata-spate	140 mm
Deplasearea stanga-dreapta	170 mm
Greutate neta	43,0 kg
Latime/inaltime/adancime	55 / 50 / 40 cm

€382
€453



ECHER MAGNETIC INCLINABIL S058

COD: S058



Dimensiune	115x115x35 mm
Degrees	45°-90°
Fora magnetica	250 N
Greutate	1,5 kg

€62.07
€81.74

Stoc limitat!



SET CALE PLAN PARALELE P014 | P015

COD: P014



€190
€224

Stoc limitat!

COD: P015



MODEL	P014	P015
Dimensiuni	150 x 10 x	160 x 4 x
	14-16-18-20-22-24-26-28-30-32-35-40-45-50 mm	10-14-18-22-26-30-34-38-42 mm
Duritate	HRC 60	HRC 60
Precizie	± 0,005 mm	± 0,005 mm
Bucati	28	18
Cutie	din lemn	din lemn
COD	P014	P015

€113
€129

SUBLERE DIGITALE CU AJUSTARE FINA C043/1000

COD: C043/1000



Gama de masurare	0 - 1000 mm
Citire	0,01 mm
Falci	150 mm
Dimensiuni tija	30 x 8 mm

€344
€641

Stoc limitat!



SUBLERE DIGITALE CU AJUSTARE FINA C043/500

COD: C043/500



Domeniu de masurare	0 ÷ 500 mm
Citire	0,01 mm
Dimensiuni falci	100 mm
Dimensiuni tija	25 x 6 mm

€204
€231



SUBLER DIGITAL C041/150

COD: C041/150



Domeniu de masurare	0 ÷ 150 mm
Citire	0,01 mm
Dimensiuni falci	40 mm
Dimensiuni tija	16 x 3 mm

€17.71
€26.69

Livrare imediata din stoc



SUBLER CU REGLARE FINA C021/500

COD: C021/500



Domeniu masurare	0 ÷ 500 mm
Citire	0,02 mm
Falci	150 mm
Dimensiuni tija	23 x 6 mm

€178
€202

Stoc limitat!



SUBLER CU REGLARE FINA C021/300

COD: C021/300



Domeniu masurare	0 ÷ 300 mm
Citire	0,02 mm
Falci	100 mm
Dimensiuni tija	23 x 6 mm

€87.26
€106

Stoc limitat!



SUBLER CU CEAS INOX C006/150

COD: C006/150



Domeniu masurare	0 ÷ 150 mm
Citire	0,02 mm
Falci	40 mm
Dimensiuni tija	16 x 3 mm

€20.71
€41.84

Livrare imediata din stoc



SUBLER DIGITAL INOX C033/300 | C033/200 | C033/150



Model	C033/300	C033/200	C033/150
Domeniu de masurare	0 ÷ 300 mm	0 ÷ 200 mm	0 ÷ 150 mm
Citire	0,01 mm	0,01 mm	0,01 mm
Tija	16 x 3,2 mm	16 x 3,2 mm	16 x 3,2 mm
Falci	60 mm	50 mm	40 mm
COD	C033/300	C033/200	C033/150
Pret lista	€113	€83.37	€50.65
Pret promotie	€71.76	€54.11	€30.07

Incepand cu
€30.07



Livrare imediata din stoc

Stoc limitat!

Stoc limitat!

SUBLER ADANCIME DIGITAL D0021300

COD: D0021300



Scara	0-300 mm
Lungime	390 mm
Latime	150 mm
Grosime tija	14.5 mm

€142
€309

Stoc limitat!



SUBLER ADANCIME DIGITAL D0021200

COD: D0021200



Scara	0-200 mm
Lungime	285 mm
Latime	100 mm
Grosime tija	14.5 mm

€94.83
€209

Stoc limitat!



SUBLER MECANIC CANALE INTERIOARE 201077

COD: 201077



Gama masurare	26 ÷ 200 mm
Citire	0.05 mm
Greutate	0.295 kg

€149
€164

Stoc limitat!



RIGLA PENTRU AFISAJ DIGITAL MASINI-UNELTE R100

COD: R100



Lungime totala	1000 mm
Domeniu masurare	900 mm
Citire	0,01 mm

€85.08
€97.89



TESTER PENTRU GROSIMI R008

COD: R008



Gama de masurare	0 - 1250 µm
Citire	0,1 µm
Precizie	± 3% ± 3% ± 2,5µm
Software integrat	

€479
€630

Stoc limitat!



DUOMETRU DIGITAL D011/A

COD: D011/A



Tester	cauciuc, elastomeri, neopren, silicon, vinil, materiale plastice moi, fetru, piele, etc
Gama de masurare	0 ÷ 100 A

€107
€128



DUOMETRU DIGITAL D011/D

COD: D011/D



Tester	plastice, formica, epoxi, plexiglass si altele similare
Gama de masurare	0 ÷ 100 D

€109
€123



CEAS COMPARATOR DIGITAL C060

COD: C060



Domeniu masurare	0 ÷ 12,7 mm
Citire	0,001 mm
Precizie	0,005 mm
Marime cadran	60 mm

€131
€223

Stoc limitat!



CEAS COMPARATOR PENTRU INTERIOR C014/15/35

COD: C014/15/35



Domeniu masurare	15-35 mm
Adancime patrundere	50 mm
Dimensiuni nicovala	3 x 3 mm
Rezolutie	0,01 mm

€78.01
€132

Stoc limitat!



CEAS COMPARATOR DE TEST DIN 2270 T005

COD: T005



Diametru ceas	32 mm
Domeniu masurare	0-0.2 mm
Citire:	0,002 mm
Precizie:	0,005 mm

€78.91
€89.68



CEAS COMPARATOR DE PRECIZIE DIN 878 C017

COD: C017



Diametru ceas	55 mm
Domeniu masurare	0-10 mm
Citire	0,01 mm
Precizie	0,015 mm

€52.19
€59.3



DISPOZITIV MASURARE CU CEAS COMPARATOR A016/250/450

COD: A016/250/450



Interval masurare	250 ÷ 450 mm
Citire	0,01 mm
Adancime masurare	400 mm

€96.86
€145

Stoc limitat!



DISPOZITIV MASURARE CU CEAS COMPARATOR A016/160/250

COD: A016/160/250



Interval masurare	160 ÷ 250 mm
Citire	0,01 mm
Adancime masurare	400 mm

€80.77
€121



DISPOZITIV MASURARE CU CEAS COMPARATOR A016/50/160

COD: A016/50/160



Interval masurare	50 ÷ 160 mm
Citire	0,01 mm
Adancime masurare	150 mm

€93.03
€106



SUPPORT MAGNETIC CEAS COMPARATOR S046

COD: S046



Tija principala	Ø 17 x 180 mm
Tija suport	Ø 14 x 200 mm
Fora de tragere	60 kg
Dimensiuni	63 x 50 x 55h mm

€76.96
€87.46



SUPPORT MAGNETIC CEAS COMPARATOR S042/2

COD: S042/2



Dimensiuni talpa	60 x 50 x 55 mm
Fora magnetica	800 N
Lungime brat	290 mm
Greutate	1,37 kg

€59.95
€68.13



SUPPORT MAGNETIC CEAS COMPARATOR S045

COD: S045



Tija principala	12 x 160 mm
Tija secundara	10 x 180 mm
Fora de tragere	600 N
Dimensiuni talpa	63 x 50 x 55h mm

€36.74
€42.84



LUPA GRADATA M072

COD: M072



Amplificare	10x
Camp vizual	24 mm

€20.95
€25.15

Stoc limitat!



ACCESORII SI CONSUMABILE

ENDOSCOP WIRELESS E023/5

COD: E023/5

FERVI



Lungime sonda	1000 mm
Diametru sonda	5,5 mm
Zoom digital	4 X
Profundimea campului	50 mm

€305
€415

Stoc limitat!



GONIOMETRU G005

COD: G005

FERVI



Domeniu masurare	0-360°
Citire	5'
Rigla	300 mm

€66.26
€75.3



AMPERMETRU DIGITAL P075

COD: P075

Livrare imediata din stoc

€96.8
€134

FERVI



Alimentare	baterii tip 9V
masurari efectuate	
ACV 750V	± 1,2 %
ACA 200 - 1000A	± 2,0 %
DCV 1000V	± 1,0 %
DCA 200 - 1000A	± 2,0 %
OHM 200k	± 1,0 %
FREQ 2k Hz	± 2,5 %



SET 6 MICROMETRE EXTERIOR M033

COD: M033

FERVI

Stoc limitat!

€143
€162



Marimi	0÷25 - 25÷50 - 50÷75 - 75÷100 - 100÷125 - 125÷150 mm
Citire	0,01 mm
Precizie	0,004 - 0,004 - 0,005 - 0,005 - 0,006 - 0,006 mm
Sina	∅ 6,3 mm
Greutate	3,81 kg



MICROMETRU DE EXTERIOR M026/25/50

COD: M026/25/50

FERVI



Gama masurare	25 ÷ 50 mm
Citire	0,001 mm
Precizie	0,0002 mm
Baterie	1 x LR44
Greutate	0,61 kg

€135
€206

Stoc limitat!



MICROMETRU M033/00/25

COD: M033/00/25

FERVI



Gama masurare	0÷25 mm
Citire	0,01 mm
Tija	∅ 6,3 mm
Greutate	0,27 kg

€14.27
€21.66

Livrare imediata din stoc



ANEOMETRU DIGITAL A005

COD: A005

FERVI

Stoc limitat!



Masurare viteza aer	0,4 - 30,0 m/s
Citire viteza aer	0,1
Precizie	± (2 % + 1 cifra)
Masurare temperatura	0°-60°C / 32°-140°F
Citire temperatura	0,1°C / 0,1°F
Precizie	0,5°C / 0,9°F
Alimentare	1 baterie 9V

€83.48
€153



MASA DE CONTROL DIN GRANIT P040

COD: P040

FERVI



Dimensiuni	310x230x80 mm
Greutate	21 kg

€58.54
€67.57



CUVA SPALARE PIESE 0305

COD: 0305

FERVI



€587
€661

Dimensiune bazin:	760 x 560 x 380 mm
Volum	8 ÷ 14 l
Putere:	1350 W
Presiune:	5 ÷ 8 bar
Consum mediu aer:	5 SCFM 145 l / min

Stoc limitat!



CUVA SPALARE PIESE 0203

COD: 0203

FERVI



€479
€504

Dimensiune bazin	770 x 595 x 700 mm
Volum	4 ÷ 9 l
Putere:	30 W
Presiune:	5 ÷ 8 bar
Consum mediu aer	5 SCFM 145 l / min



TAMBUR CU CABLU RETRACTABIL 0621/A3

COD: 0621/A3

Fara lampa

FERVI



Lungime cablu	10 m
Tip cablu H05VV-F	3x1,50 mm²
Alimentare	12V la 240 V
Putere max. cablul roluit	1200W
Putere max. cablu neroluit	1800W

€79.75
€90.62

Stoc limitat!



CRIC HIDRAULIC CU TALPA 0658

COD: 0658

FERVI

Stoc limitat!



Capacitate	10 tone
Cursa picior	30 - 260 mm
Inaltimea max. cap	420 - 650 mm

€586
€659



CRIC HIDRAULIC TIP BUTELIE 0062/20

COD: 0062/20

FERVI



Greutate	11 kg
Capacitate	20 T
Inaltime de ridicare	150 mm
Inaltime minima	235 mm
Inaltime ajustabila	60 mm



€37.79
€83.24



TROLIU MANUAL ZINCAT 0070/C | 0070

FERVI

BEST SELLER



Model	0070/C	0070
Capacitate maxima	500 kg	500 kg
Dimensiuni cablu	∅ 4,5 mm x 10 m	-
Greutate	3,62 kg	2,59 kg
COD	0070/C	0070
Pret lista	€47.74	€33.09
Pret promotie	€41.27	€23.21

Incepand cu
€23.21



Livrare imediata din stoc

Livrare imediata din stoc

PALAN MANUAL CU PARGHIE 0237/15

COD: 0237/15

FERVI



Capacitate max.	1500 Kg
Inaltime ridicare	1,5 m
Greutate:	10,55 Kg

€235
€287

Stoc limitat!



ACCESORII SI CONSUMABILE

ELECTROPALAN LN-1000 | LN-800 | LN-600

Livrare imediata din stoc

PROMA



Model	LN-1000	LN-800	LN-600
Sarcina utila (1 fir)/(2 fire)	500 kg / 1000 kg	400 kg / 800 kg	300 kg / 600 kg
Inaltime ridicare (1 fir)/(2 fire)	12 m / 6 m		
Putere motor	1,6 kW/ 230V	1,35 kW/ 230V	1,05 kW/ 230V
Greutate	32 kg	20 kg	18 kg
COD	25061009	25061008	25600000
Pret lista	€486	€333	€256
Pret promotie	€395	€295	€238

Inceput cu
€238



PALAN MANUAL CU LANT RZ-33 | RZ-13

PROMA



Model	RZ-33	RZ-13
Greutate de ridicare	2200 kg	750 kg
Inaltime de ridicare	3 m	3 m
Greutate proprie	25 kg	10 kg
COD	25003030	25001030
Pret lista	€177	€101
Pret promotie	€150	€58.35

Inceput cu
€58.35



Livrare imediata din stoc

CARUCIOR CU ROTI CU 3 RAFTURI C650 **Stoc limitat!**

COD: C650



FERVI

Dimensiuni generale	800x450x800 mm
Grosime tabla	1,5 mm
Diametru roti	ø 80 mm
Capacitate max. incarcare	100 kg
Greutate	23 kg

€92.29
€169



STIVUITOR MANUAL 0143A **Stoc limitat!**

COD: 0143A



€1565
€1739

FERVI

Capacitate	1000 Kg
Cursa furca min/max	90/1600 mm
Dimensiuni platforma	1150x550 mm



MAGNET PERMANENT P073 **Stoc limitat!**

COD: P073

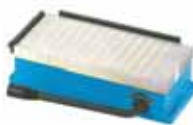

€668
€891

FERVI

Dimensiuni	500 x 200 x 80h mm
Forta magnetica max.	120 N/cm2
Pas	16 / 12+4 mm
Greutate	48 kg



MAGNET PERMANENT S0600 **Stoc limitat!**

COD: S0600



€438
€774

FERVI

Capacitatea ridicare	600 kg
Capacitatea ridicare rotund	200 kg
Diametru ridicat	70-400 mm
Diametru	55 mm
Greutate	19 kg



TRUSA DE TAROZI SI FILIERE M2-M18 M218

COD: M218



€187
€212

FERVI

Trusa contine	110 piese M 2-18 mm
Support pentru tarozi	x2 buc
Support filiera	x2 buc



TRUSA DE TAROZI SI FILIERE M6-M24 M100

COD: M100



€88.5
€138

FERVI

Trusa contine	45 piese M 6-24 mm
Support tarozi	x1 buc
Support filiera	x1 buc



TRUSA DE REPARATII FILET DIN OTEL M5-M12 E010

COD: E010



€103
€117

FERVI

Filete	M5=25 M6=25 M8=25 M10=25 M12=10
Manere T	5 buc
Tarozi	M5=1 M6=1 M8=1 M10=1 M12=1
Burghie	5,2=1 6,3=1 8,3=1 10,4=1 12,4=1 mm
Greutate	2,38 kg



DULAP PENTRU SCULE C190C **Stoc limitat!**

COD: C190C



€631
€872

FERVI

Dimensiuni	1000x470x920h mm
2 sertare	560x400x40h mm
4 sertare	560x400x60h mm
1 sertar	560x400x170h mm
12 tavi	cu 152 unelte
Greutate	80 kg



DULAP SCULE CU ROTI C960C **Stoc limitat!**

COD: C960C



€329
€462

FERVI

5 sertare	650x405x65 mm
1 sertar	650x405x115 mm
Dimensiuni	680x510x800 mm
Greutate	55 kg

- Dispozitiv pentru derolat hartie
- 2 roti fixe si 2 mobile
- Turse de scule incluse



DULAP PENTRU SCULE C603

COD: C603



€444
€884

FERVI

6 sertare culisante cu inchidere	
Dimensiuni	630x550x930 mm
3 sertare	517x440x73 mm
2 sertare	517x440x115 mm
1 sertar	517x440x175 mm
Greutate	53,5 kg



DULAP PENTRU SCULE C900/B **Livrare imediata din stoc**

COD: C900/B



€337
€383

FERVI

6 sertare	cu inchidere centralizata
Dimensiuni	744x461x964 mm
Greutate	54 kg

- 2 roti fixe si 2 mobile



SET SCULE 175 BUC 0165 **Stoc limitat!**

COD: 0165



€226
€261

FERVI

Trusa contine	175 de scule
Dimensiuni	500 x 440 x 200/270 mm
Carucior	1 buc.



VALIZA CU SCULE 130 PIESE 0110

COD: 0110



€167
€210

FERVI

Trusa contine	130 de scule
Greutate	9,8 kg

Stoc limitat!



ACCESORII SI CONSUMABILE

TRUSA 40 CHEI TUBULARE IMPACT LUNGI SI SCURTE I340

COD: I340



1/2" prize	Dr.9 - 30 mm
1/2" prize lungi	Dr.9 - 30 mm
Articulate universală	1/2"
1/2"	Dr 125 mm

Stoc limitat!

€131
€207



TRUSA CHEI TUBULARE 94 BUC. 0618

COD: 0618



Trusa chei tubulare	94-buc
in cruce, drepte, in stea, torx, hex	

Stoc limitat!

€143
€174



SET 7 CHEI TORX 0400

COD: 0400



Set chei torx	2 - 3 - 4 - 5 - 6 - 8 - 10 mm
Material Chrome Vanadium	

€55.92
€69.8



CHEIE DINAMOMETRICA CU 11 CAPETE 0803/S210

COD: 0803/S210



Stoc limitat!

Precizie	±4%
Capete cheie	13-14-15-17-19-22-24-27-30 mm
Cap dinamometric	14x18 mm
Prindere	1/2"



€158
€289



CHEIE DINAMOMETRICA 0270

COD: 0270



Capacitate	90, 110, 135, 160, 190 Nm
Precizie	0.1 Nm
Numar dinti	36
Oprire automata	80"
Dr	1/2"

Stoc limitat!

€151
€195



CAPSATOR PNEUMATIC CUIE 0586

COD: 0586



Livrare imediata din stoc

Capacitate incarcator	110 buc
Presiune	5-7 bar
Cuie	F-10/50 mm
Dimensiuni	245x225x55 mm
Greutate	1,48 kg

€39.02
€72.62



TRUSA PISTOL PNEUMATIC 0044

Stoc limitat!

COD: 0044



Racord de aer	1/4"
Viteza rotatie	7000 rpm
Moment torsiune max.	320 Nm
Consum aer comprimat	150 l/min
Presiune	6 bar
Greutate	4,2 kg

€68.2
€81.75



SLEFUITOR PNEUMATIC ORBITAL 0460

COD: 0460



Livrare imediata din stoc

Diametru disc	150 mm
Diametru platou orbital	2,5 mm
Turatii max.	10500 rpm
Consum mediu aer	85 l/min

€76.86
€100



FINANȚARE PRIN PARTENERII NOȘTRI

LEASING CU DOBÂNDĂ

0%+ERB3M

SAU

**2,99% DOBÂNDĂ
FIXĂ**

ACCESEAZĂ PROGRAMUL
NOSTRU DE FINANȚARE
PRIN **LEASING ȘI VÂNZARE
ÎN RATE!**

UTILAJE NOI ȘI PERFORMANTE

ÎNTRECE-ȚI CONCURENȚA ✓

CREȘTE-ȚI PERFORMANȚA ✓

ACHIZIȚIONEAZĂ ✓

*detalii pe: www.proma.ro/finantare

GRENKE®

SISTEM DE FINANȚARE

0%
AVANS

CHIRIA ÎN
€
CONSTANTĂ
PE DURATA
CONTRACTULUI

24 ORE
RĂSPUNS RAPID
LA CERERE
DE FINANȚARE

AVANTAJE

€€
FACTURA DE CHIRIE
DEDUCTIBILĂ



CLIEȚI ELIGIBILI

- :: Persoane juridice
- :: Persoane fizice autorizate
(notari, avocați, medici, arhitecți, etc)



CONDIȚII DE ÎNCHIRIERE

- :: Valoarea minima contract: **500 € + TVA**
- :: Perioada contract **18 - 60** luni



PAȘI DE URMAT

- :: Alege produsele de care ai nevoie împreună
cu specialiștii noștri și trimite documentația
către finantare@proma.ro
Produsele vor fi comandate/livrate după
semnarea contractului



S.C. Proma Machinery S.R.L.

Birouri și Showroom

Șos. de Centură, Nr. 45, com. Chiajna, Jud. Ilfov

Tel: 021 448 04 50; Fax: 021 448 04 86

Mobil: 0735 556 732; 0726 123 472; 0732 660 151

E-mail: info@proma.ro